

Lecture Notes

On

OPERATING SYSTEM

Prepared by,

A.SANDEEP.

ASSISTANT PROFESSOR.

CSE



OPERATING SYSTEM

LECTURE NOTES

OPERATING SYSTEM

Lecture Notes

Lecture #1

What is an Operating System?

- ⇒ A program that acts as an intermediary between a user of a computer and the computer hardware.
- ⇒ An operating System is a collection of system programs that together control the operations of a computer system.

Some examples of operating systems are UNIX, Mach, MS-DOS, MS-Windows, Windows/NT, Chicago, OS/2, MacOS, VMS, MVS, and VM.

Operating system goals:

- Execute user programs and make solving user problems easier.
- Make the computer system convenient to use.
- Use the computer hardware in an efficient manner.

Computer System Components

1. **Hardware** – provides basic computing resources (CPU, memory, I/O devices).
2. **Operating system** – controls and coordinates the use of the hardware among the various application programs for the various users.
3. **Applications programs** – Define the ways in which the system resources are used to solve the computing problems of the users (compilers, database systems, video games, business programs).
4. **Users** (people, machines, other computers).

Abstract View of System Components

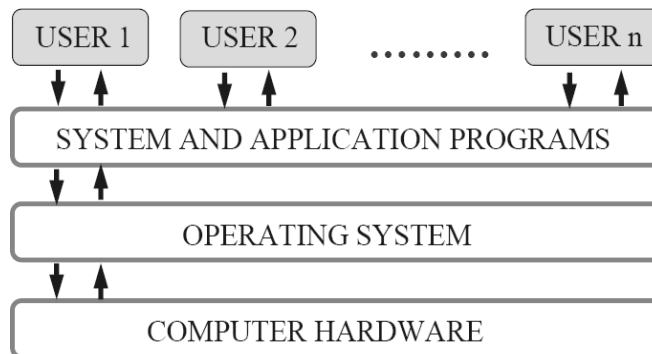

Operating System Definitions

Resource allocator – manages and allocates resources.

Control program – controls the execution of user programs and operations of I/O devices .

Kernel – The one program running at all times (all else being application programs).

Components of OS: OS has two parts. (1)Kernel.(2)Shell.

(1) Kernel is an active part of an OS i.e., it is the part of OS running at all times. It is a programs which can interact with the hardware. Ex: Device driver, dll files, system files etc.

(2) Shell is called as the command interpreter. It is a set of programs used to interact with the application programs. It is responsible for execution of instructions given to OS (called commands).

Operating systems can be explored from two viewpoints: the user and the system.

User View: From the user's point view, the OS is designed for one user to monopolize its resources, to maximize the work that the user is performing and for ease of use.

System View: From the computer's point of view, an operating system is a control program that manages the execution of user programs to prevent errors and improper use of the computer. It is concerned with the operation and control of I/O devices.



Lecture #2

Functions of Operating System:

Process Management

A *process* is a program in execution. A process needs certain resources, including CPU time, memory, files, and I/O devices, to accomplish its task.

The operating system is responsible for the following activities in connection with process management.

- ◆ Process creation and deletion.
- ◆ process suspension and resumption.
- ◆ Provision of mechanisms for:
 - process synchronization
 - process communication

Main-Memory Management

Memory is a large array of words or bytes, each with its own address. It is a repository of quickly accessible data shared by the CPU and I/O devices.

Main memory is a volatile storage device. It loses its contents in the case of system failure.

The operating system is responsible for the following activities in connections with memory management:

- ◆ Keep track of which parts of memory are currently being used and by whom.
- ◆ Decide which processes to load when memory space becomes available.
- ◆ Allocate and de-allocate memory space as needed.

File Management

A file is a collection of related information defined by its creator. Commonly, files represent programs (both source and object forms) and data.

The operating system is responsible for the following activities in connections with file management:

- ◆ File creation and deletion.
- ◆ Directory creation and deletion.
- ◆ Support of primitives for manipulating files and directories.
- ◆ Mapping files onto secondary storage.
- ◆ File backup on stable (nonvolatile) storage media.

I/O System Management

The I/O system consists of:

- ◆ A buffer-caching system
- ◆ A general device-driver interface
- ◆ Drivers for specific hardware devices

Secondary-Storage Management

Since main memory (*primary storage*) is volatile and too small to accommodate all data and programs permanently, the computer system must provide *secondary storage* to back up main memory.

Most modern computer systems use disks as the principle on-line storage medium, for both programs and data.

The operating system is responsible for the following activities in connection with disk management:

- ◆ Free space management
- ◆ Storage allocation
- ◆ Disk scheduling

Networking (Distributed Systems)

- ◆ A *distributed* system is a collection processors that do not share memory or a clock. Each processor has its own local memory.
- ◆ The processors in the system are connected through a communication network.
- ◆ Communication takes place using a *protocol*.
- ◆ A distributed system provides user access to various system resources.
- ◆ Access to a shared resource allows:
- ◆ Computation speed-up

- ◆ Increased data availability
- ◆ Enhanced reliability

Protection System

- ◆ *Protection* refers to a mechanism for controlling access by programs, processes, or users to both system and user resources.
- ◆ The protection mechanism must:
 - ◆ distinguish between authorized and unauthorized usage.
 - ◆ specify the controls to be imposed.
 - ◆ provide a means of enforcement.

Command-Interpreter System

- Many commands are given to the operating system by control statements which deal with:
 - ◆ process creation and management
 - ◆ I/O handling
 - ◆ secondary-storage management
 - ◆ main-memory management
 - ◆ file-system access
 - ◆ protection
 - ◆ networking
 - The program that reads and interprets control statements is called variously:
 - ◆ command-line interpreter
 - ◆ shell (in UNIX)
 - Its function is to get and execute the next command statement.

Operating-System Structures

- System Components
- Operating System Services
- System Calls
- System Programs
- System Structure
- Virtual Machines
- System Design and Implementation
- System Generation

Common System Components

- Process Management
- Main Memory Management
- File Management
- I/O System Management
- Secondary Management
- Networking
- Protection System
- Command-Interpreter System

Lecture #3

Evolution of OS:

1. Mainframe Systems

Reduce setup time by batching similar jobs Automatic job sequencing – automatically transfers control from one job to another. First rudimentary operating system. Resident monitor

- initial control in monitor
- control transfers to job
- when job completes control transfers back to monitor

2. Batch Processing Operating System:

- This type of OS accepts more than one jobs and these jobs are batched/ grouped together according to their similar requirements. This is done by computer operator. Whenever the computer becomes available, the batched jobs are sent for execution and gradually the output is sent back to the user.
- It allowed only one program at a time.
- This OS is responsible for scheduling the jobs according to priority and the resource required.

3. Multiprogramming Operating System:

- This type of OS is used to execute more than one jobs simultaneously by a single processor. it increases CPU utilization by organizing jobs so that the CPU always has one job to execute.
- The concept of multiprogramming is described as follows:
 - All the jobs that enter the system are stored in the job pool(in disc). The operating system loads a set of jobs from job pool into main memory and begins to execute.
 - During execution, the job may have to wait for some task, such as an I/O operation, to complete. In a multiprogramming system, the operating system simply switches to another job and executes. When that job needs to wait, the CPU is switched to *another* job, and so on.
 - When the first job finishes waiting and it gets the CPU back.
 - As long as at least one job needs to execute, the CPU is never idle.

Multiprogramming operating systems use the mechanism of job scheduling and CPU scheduling.

3. Time-Sharing/multitasking Operating Systems

Time sharing (or multitasking) OS is a logical extension of multiprogramming. It provides extra facilities such as:

- Faster switching between multiple jobs to make processing faster.
- Allows multiple users to share computer system simultaneously.
- The users can interact with each job while it is running.

These systems use a concept of virtual memory for effective utilization of memory space. Hence, in this OS, no jobs are discarded. Each one is executed using virtual memory concept. It uses CPU scheduling, memory management, disc management and security management. Examples: CTSS, MULTICS, CAL, UNIX etc.

4. Multiprocessor Operating Systems

Multiprocessor operating systems are also known as parallel OS or tightly coupled OS. Such operating systems have more than one processor in close communication that sharing the computer bus, the clock and sometimes memory and peripheral devices. It executes multiple jobs at same time and makes the processing faster.

Multiprocessor systems have three main advantages:

- **Increased throughput:** By increasing the number of processors, the system performs more work in less time. The speed-up ratio with N processors is less than N.
- **Economy of scale:** Multiprocessor systems can save more money than multiple single-processor systems, because they can share peripherals, mass storage, and power supplies.
- **Increased reliability:** If one processor fails to done its task, then each of the remaining processors must pick up a share of the work of the failed processor. The failure of one processor will not halt the system, only slow it down.

The ability to continue providing service proportional to the level of surviving hardware is called **graceful degradation**. Systems designed for graceful degradation are called **fault tolerant**.

The multiprocessor operating systems are classified into two categories:

1. Symmetric multiprocessing system
2. Asymmetric multiprocessing system

- ⊃ In symmetric multiprocessing system, each processor runs an identical copy of the operating system, and these copies communicate with one another as needed.
- ⊃ In asymmetric multiprocessing system, a processor is called master processor that controls other processors called slave processor. Thus, it establishes master-slave relationship. The master processor schedules the jobs and manages the memory for entire system.

5. Distributed Operating Systems

- ⊃ In distributed system, the different machines are connected in a network and each machine has its own processor and own local memory.
- ⊃ In this system, the operating systems on all the machines work together to manage the collective network resource.
- ⊃ It can be classified into two categories:
 1. Client-Server systems
 2. Peer-to-Peer systems

Advantages of distributed systems.

- ⊃ Resources Sharing
- ⊃ Computation speed up – load sharing
- ⊃ Reliability
- ⊃ Communications
- ⊃ Requires networking infrastructure.
- ⊃ Local area networks (LAN) or Wide area networks (WAN)

6. Desktop Systems/Personal Computer Systems

- ⊃ The PC operating system is designed for maximizing user convenience and responsiveness. This system is neither multi-user nor multitasking.
- ⊃ These systems include PCs running Microsoft Windows and the Apple Macintosh. The MS-DOS operating system from Microsoft has been superseded by multiple flavors of Microsoft Windows and IBM has upgraded MS-DOS to the OS/2 multitasking system.
- ⊃ The Apple Macintosh operating system has been ported to more advanced hardware, and now includes new features such as virtual memory and multitasking.

7. Real-Time Operating Systems (RTOS)

- ⊃ A real-time operating system (RTOS) is a multitasking operating system intended for applications with fixed deadlines (real-time computing). Such applications include some small embedded systems, automobile engine controllers, industrial robots, spacecraft, industrial control, and some large-scale computing systems.
- ⊃ The real time operating system can be classified into two categories:
 1. hard real time system and 2. soft real time system.
- ⊃ A **hard real-time** system guarantees that critical tasks be completed on time. This goal requires that all delays in the system be bounded, from the retrieval of stored data to the time that it takes the operating system to finish any request made of it. Such time constraints dictate the facilities that are available in hard real-time systems.
- ⊃ A **soft real-time** system is a less restrictive type of real-time system. Here, a critical real-time task gets priority over other tasks and retains that priority until it completes. Soft real time system can be mixed with other types of systems. Due to less restriction, they are risky to use for industrial control and robotics.

Lecture #4

Operating System Services

Following are the five services provided by operating systems to the convenience of the users.

1. Program Execution

The purpose of computer systems is to allow the user to execute programs. So the operating system provides an environment where the user can conveniently run programs. Running a program involves the allocating and deallocating memory, CPU scheduling in case of multiprocessing.

2. I/O Operations

Each program requires an input and produces output. This involves the use of I/O. So the operating systems are providing I/O makes it convenient for the users to run programs.

3. File System Manipulation

The output of a program may need to be written into new files or input taken from some files. The operating system provides this service.

4. Communications

The processes need to communicate with each other to exchange information during execution. It may be between processes running on the same computer or running on the different computers. Communications can be occur in two ways: (i) shared memory or (ii) message passing

5. Error Detection

An error is one part of the system may cause malfunctioning of the complete system. To avoid such a situation operating system constantly monitors the system for detecting the errors. This relieves the user of the worry of errors propagating to various part of the system and causing malfunctioning.

Following are the three services provided by operating systems for ensuring the efficient operation of the system itself.

1. Resource allocation

When multiple users are logged on the system or multiple jobs are running at the same time, resources must be allocated to each of them. Many different types of resources are managed by the operating system.

2. Accounting

The operating systems keep track of which users use how many and which kinds of computer resources. This record keeping may be used for accounting (so that users can be billed) or simply for accumulating usage statistics.

3. Protection

When several disjointed processes execute concurrently, it should not be possible for one process to interfere with the others, or with the operating system itself. Protection involves ensuring that all access to system resources is controlled. Security of the system from outsiders is also important. Such security starts with each user having to authenticate him to the system, usually by means of a password, to be allowed access to the resources.

System Call:

- System calls provide an interface between the process and the operating system.
- System calls allow user-level processes to request some services from the operating system which process itself is not allowed to do.
- For example, for I/O a process involves a system call telling the operating system to read or write particular area and this request is satisfied by the operating system.

The following different types of system calls provided by an operating system:

Process control

- end, abort
- load, execute

- create process, terminate process
- get process attributes, set process attributes
- wait for time
- wait event, signal event
- allocate and free memory

File management

- create file, delete file
- open, close
- read, write, reposition
- get file attributes, set file attributes

Device management

- request device, release device
- read, write, reposition
- get device attributes, set device attributes
- logically attach or detach devices

Information maintenance

- get time or date, set time or date
- get system data, set system data
- get process, file, or device attributes
- set process, file, or device attributes

Communications

- create, delete communication connection
- send, receive messages
- transfer status information
- attach or detach remote devices

An Operating System Layer

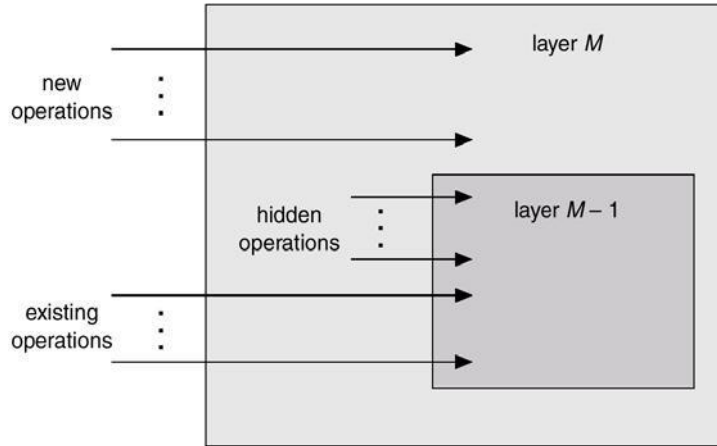

OS/2 Layer Structure

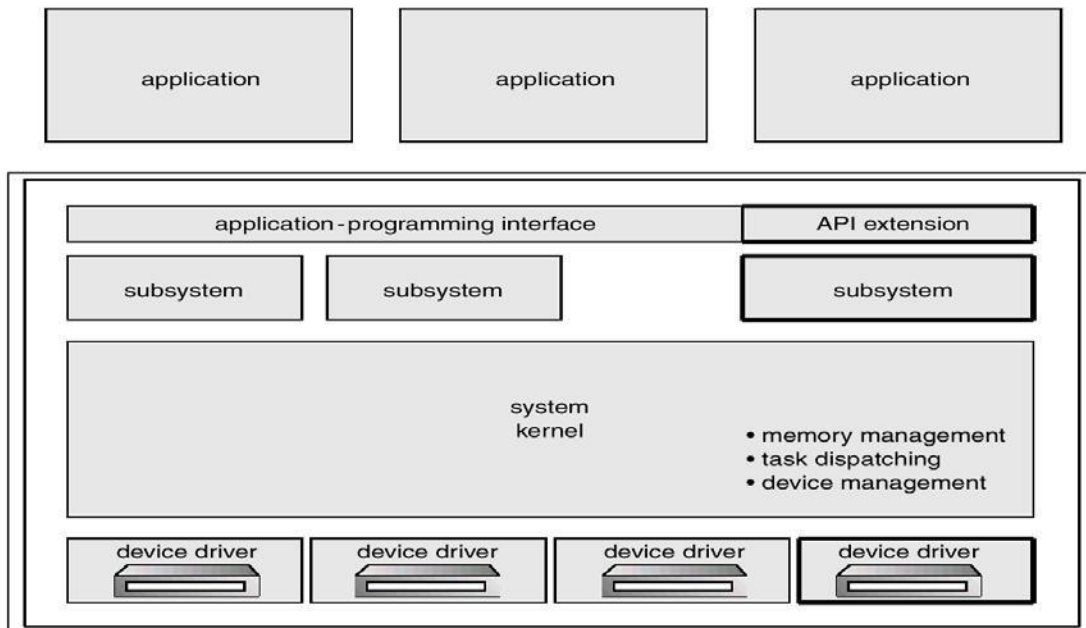

Microkernel System Structure

Moves as much from the kernel into "user" space. Communication takes place between user modules using message passing.

Benefits:

- easier to extend a microkernel
- easier to port the operating system to new architectures
- more reliable (less code is running in kernel mode)
- more secure

Virtual Machines

- A *virtual machine* takes the layered approach to its logical conclusion. It treats hardware and the operating system kernel as though they were all hardware.
- A virtual machine provides an interface *identical* to the underlying bare hardware.
- The operating system creates the illusion of multiple processes, each executing on its own processor with its own (virtual) memory.
- The resources of the physical computer are shared to create the virtual machines.
 - ◆ CPU scheduling can create the appearance that users have their own processor.
 - ◆ Spooling and a file system can provide virtual card readers and virtual line printers.
 - ◆ A normal user time-sharing terminal serves as the virtual machine operator's console.

- **System Models**

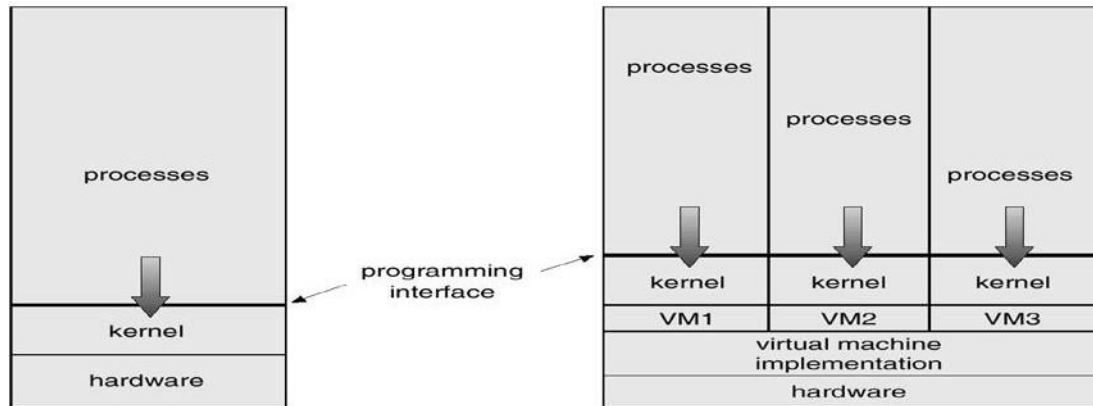

Non-virtual Machine

Virtual Machine

- **Advantages/Disadvantages of Virtual Machines**

- The virtual-machine concept provides complete protection of system resources since each virtual machine is isolated from all other virtual machines. This isolation, however, permits no direct sharing of resources.
- A virtual-machine system is a perfect vehicle for operating-systems research and development. System development is done on the virtual machine, instead of on a physical machine and so does not disrupt normal system operation.
- The virtual machine concept is difficult to implement due to the effort required to provide an *exact* duplicate to the underlying machine.

System Generation (SYSGEN)

Operating systems are designed to run on any of a class of machines at a variety of sites with a variety of peripheral configurations. The system must then be configured or generated for each specific computer site, a process sometimes known as system generation (SYSGEN).

SYSGEN program obtains information concerning the specific configuration of the hardware system. To generate a system, we use a special program. The SYSGEN program reads from a given file, or asks the operator of the system for information concerning the specific configuration of the hardware system, or probes the hardware directly to determine what components are there.

The following kinds of information must be determined.

What CPU will be used? What options (extended instruction sets, floating point arithmetic, and so on) are installed? For multiple-CPU systems, each CPU must be described.

How much memory is available? Some systems will determine this value themselves by referencing memory location after memory location until an "illegal address" fault is generated. This procedure defines the final legal address and hence the amount of available memory.

What devices are available? The system will need to know how to address each device (the device number), the device interrupt number, the device's type and model, and any special device characteristics.

What operating-system options are desired, or what parameter values are to be used? These options or values might include how many buffers of which sizes should be used, what type of CPU-scheduling algorithm is desired, what the maximum number of processes to be supported is.

Booting –The procedure of starting a computer by loading the kernel is known as booting the system. Most computer systems have a small piece of code, stored in ROM, known as the bootstrap program or bootstrap loader. This code is able to locate the kernel, load it into main memory, and start its execution. Some computer systems, such as PCs, use a two-step process in which a simple bootstrap loader fetches a more complex boot program from disk, which in turn loads the kernel.

Lecture #5

Computer-System Architecture

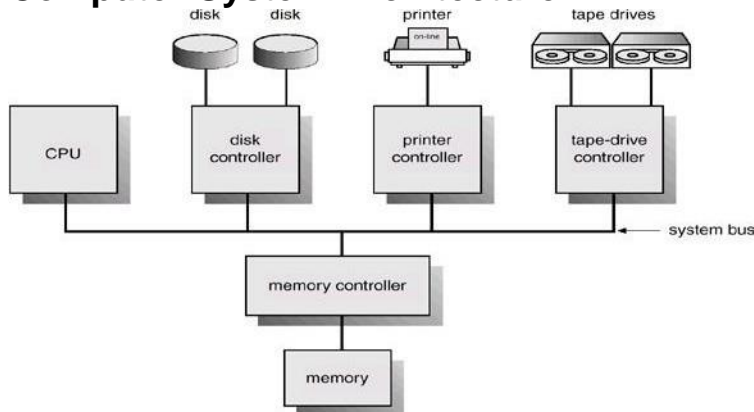

Computer-System Operation

- I/O devices and the CPU can execute concurrently.
- Each device controller is in charge of a particular device type.
- Each device controller has a local buffer.
- CPU moves data from/to main memory to/from local buffers
- I/O is from the device to local buffer of controller.
- Device controller informs CPU that it has finished its operation by causing an *interrupt*.

Common Functions of Interrupts

- Interrupt transfers control to the interrupt service routine generally, through the *interrupt vector*, which contains the addresses of all the service routines.
- Interrupt architecture must save the address of the interrupted instruction.
- Incoming interrupts are *disabled* while another interrupt is being processed to prevent a *lost interrupt*.
- A *trap* is a software-generated interrupt caused either by an error or a user request.
- An operating system is *interrupt driven*.

Interrupt Handling

- The operating system preserves the state of the CPU by storing registers and the program counter.
- Determines which type of interrupt has occurred: *polling*, *vectored* interrupt system
- Separate segments of code determine what action should be taken for each type of interrupt

Interrupt Time Line For a Single Process Doing Output

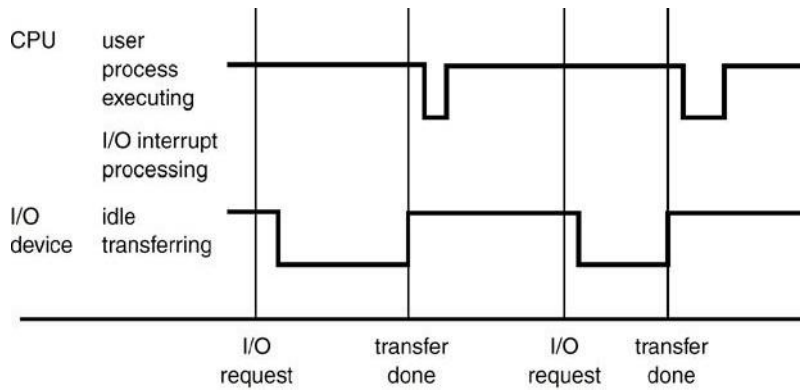

I/O Structure

After I/O starts, control returns to user program only upon I/O completion.

- ◆ Wait instruction idles the CPU until the next interrupt
- ◆ Wait loop (contention for memory access).
- ◆ At most one I/O request is outstanding at a time, no simultaneous I/O processing.

After I/O starts, control returns to user program without waiting for I/O completion.

- ◆ *System call* – request to the operating system to allow user to wait for I/O completion.
- ◆ *Device-status table* contains entry for each I/O device indicating its type, address, and state.
- ◆ Operating system indexes into I/O device table to determine device status and to modify table entry to include interrupt.

Two I/O Methods

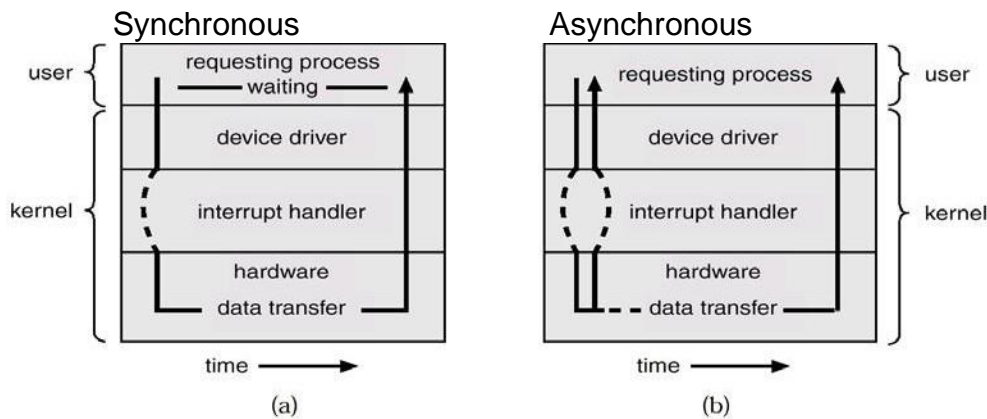

Device-Status Table

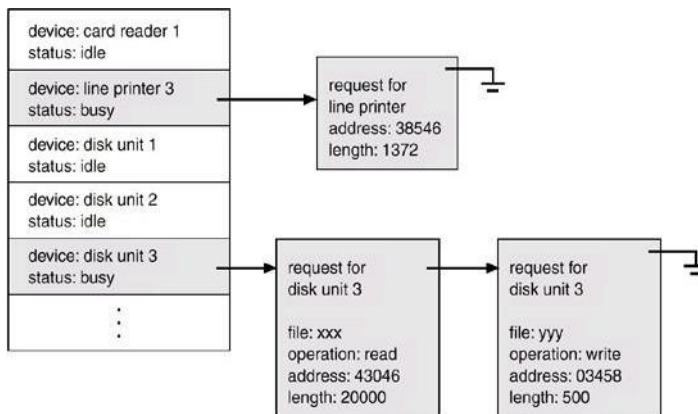

Direct Memory Access Structure

- Used for high-speed I/O devices able to transmit information at close to memory speeds.
- Device controller transfers blocks of data from buffer storage directly to main memory without CPU intervention.
- Only one interrupt is generated per block, rather than the one interrupt per byte.

Storage Structure

Main memory – only large storage media that the CPU can access directly.

Secondary storage – extension of main memory that provides large nonvolatile storage capacity.

Magnetic disks – rigid metal or glass platters covered with magnetic recording material

- ◆ Disk surface is logically divided into *tracks*, which are subdivided into *sectors*.
- ◆ The *disk controller* determines the logical interaction between the device and the computer.

Storage Hierarchy

Storage systems organized in hierarchy.

- ◆ Speed
- ◆ Cost
- ◆ Volatility

Caching – copying information into faster storage system; main memory can be viewed as a last *cache* for secondary storage.

- Use of high-speed memory to hold recently-accessed data.
- Requires a *cache management* policy.
- Caching introduces another level in storage hierarchy.
- This requires data that is simultaneously stored in more than one level to be *consistent*.

Storage-Device Hierarchy

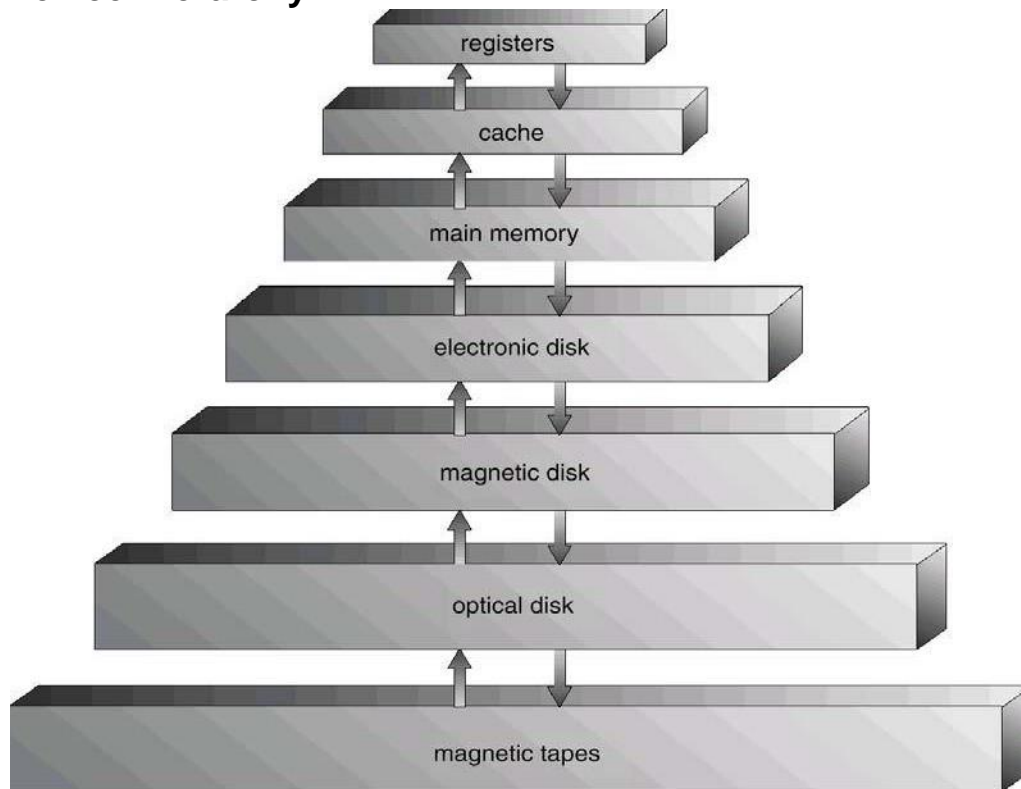

Hardware Protection

- Dual-Mode Operation

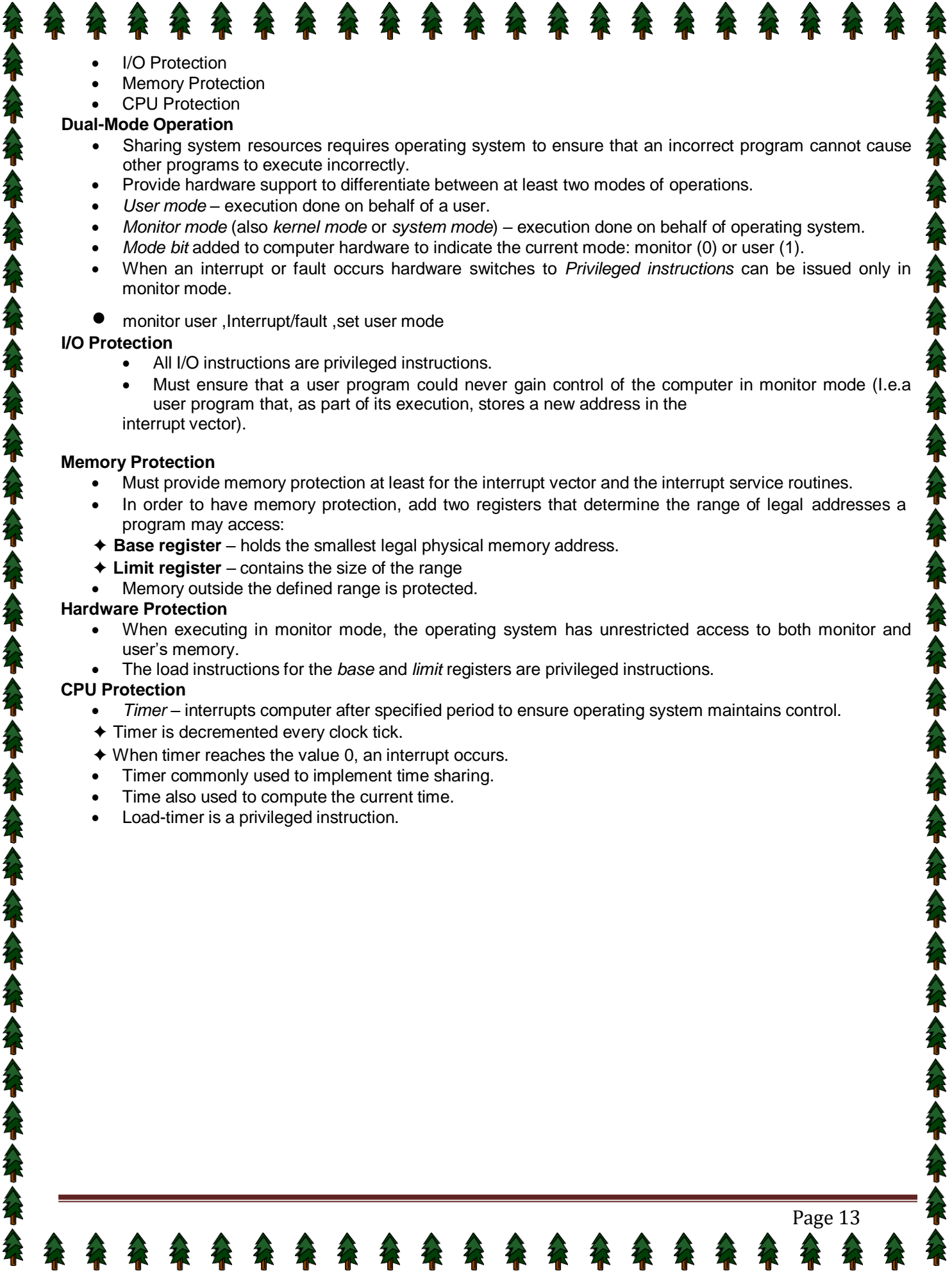
- 
- I/O Protection
 - Memory Protection
 - CPU Protection

Dual-Mode Operation

- Sharing system resources requires operating system to ensure that an incorrect program cannot cause other programs to execute incorrectly.
- Provide hardware support to differentiate between at least two modes of operations.
- *User mode* – execution done on behalf of a user.
- *Monitor mode* (also *kernel mode* or *system mode*) – execution done on behalf of operating system.
- *Mode bit* added to computer hardware to indicate the current mode: monitor (0) or user (1).
- When an interrupt or fault occurs hardware switches to *Privileged instructions* can be issued only in monitor mode.
- monitor user ,Interrupt/fault ,set user mode

I/O Protection

- All I/O instructions are privileged instructions.
- Must ensure that a user program could never gain control of the computer in monitor mode (I.e.a user program that, as part of its execution, stores a new address in the interrupt vector).

Memory Protection

- Must provide memory protection at least for the interrupt vector and the interrupt service routines.
- In order to have memory protection, add two registers that determine the range of legal addresses a program may access:
 - ◆ **Base register** – holds the smallest legal physical memory address.
 - ◆ **Limit register** – contains the size of the range
- Memory outside the defined range is protected.

Hardware Protection

- When executing in monitor mode, the operating system has unrestricted access to both monitor and user's memory.
- The load instructions for the *base* and *limit* registers are privileged instructions.

CPU Protection

- *Timer* – interrupts computer after specified period to ensure operating system maintains control.
- ◆ Timer is decremented every clock tick.
- ◆ When timer reaches the value 0, an interrupt occurs.
- Timer commonly used to implement time sharing.
- Time also used to compute the current time.
- Load-timer is a privileged instruction.

Lecture #6(UNIT-II)

Process Concept

- Informally, a process is a program in execution. A process is more than the program code, which is sometimes known as the text section. It also includes the current activity, as represented by the value of the program counter and the contents of the processor's registers. In addition, a process generally includes the process stack, which contains temporary data (such as method parameters, return addresses, and local variables), and a data section, which contains global variables.
- An operating system executes a variety of programs:
 - ◆ Batch system – jobs
 - ◆ Time-shared systems – user programs or tasks
 - Process – a program in execution; process execution must progress in sequential fashion.
 - A process includes: program counter , stack, data section

Process State

As a process executes, it changes *state*

- ⇒ **New State:** The process is being created.
- ⇒ **Running State:** A process is said to be running if it has the CPU, that is, process actually using the CPU at that particular instant.
- ⇒ **Blocked (or waiting) State:** A process is said to be blocked if it is waiting for some event to happen such that as an I/O completion before it can proceed. Note that a process is unable to run until some external event happens.
- ⇒ **Ready State:** A process is said to be ready if it needs a CPU to execute. A ready state process is runnable but temporarily stopped running to let another process run.
- ⇒ **Terminated state:** The process has finished execution.

What is the difference between process and program?

- 1) Both are same beast with different name or when this beast is sleeping (not executing) it is called program and when it is executing becomes process.
- 2) Program is a static object whereas a process is a dynamic object.
- 3) A program resides in secondary storage whereas a process resides in main memory.
- 4) The span time of a program is unlimited but the span time of a process is limited.
- 5) A process is an 'active' entity whereas a program is a 'passive' entity.
- 6) A program is an algorithm expressed in programming language whereas a process is expressed in assembly language or machine language.

Diagram of Process State

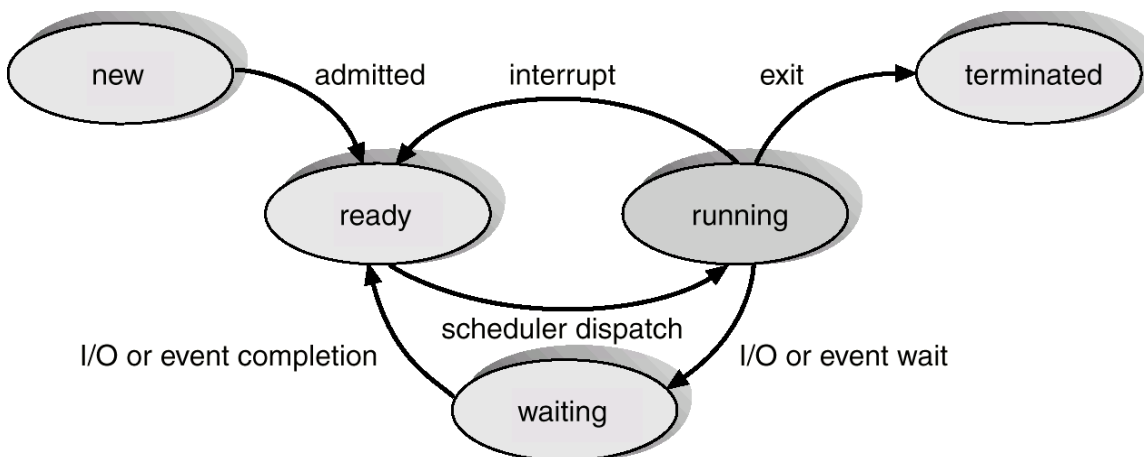

Lecture #7.#8

Process Control Block (PCB)

Information associated with each process.

process number
program counter
registers
memory limits
list of open files
⋮

- Process state
- Program counter
- CPU registers
- CPU scheduling information
- Memory-management information
- Accounting information
- I/O status information

Process state: The state may be new, ready, running, waiting, halted, and SO on.

Program counter: The counter indicates the address of the next instruction to be executed for this process.

CPU registers: The registers vary in number and type, depending on the computer architecture. They include accumulators, index registers, stack pointers, and general-purpose registers, plus any condition-code information. Along with the program counter, this state information must be saved when an interrupt occurs, to allow the process to be continued correctly afterward.

CPU-scheduling information: This information includes a process priority, pointers to scheduling queues, and any other scheduling parameters.

Memory-management information: This information may include such information as the value of the base and limit registers, the page tables, or the segment tables, depending on the memory system used by the operating system.

Accounting information: This information includes the amount of CPU and real time used, time limits, account numbers, job or process numbers, and so on.

status information: The information includes the list of I/O devices allocated to this process, a list of open files, and so on.

The PCB simply serves as the repository for any information that may vary from process to process.

Process Scheduling Queues

- ↻ **Job Queue:** This queue consists of all processes in the system; those processes are entered to the system as new processes.
- ↻ **Ready Queue:** This queue consists of the processes that are residing in main memory and are ready and waiting to execute by CPU. This queue is generally stored as a linked list. A ready-queue header contains pointers to the first and final PCBs in the list. Each PCB includes a pointer field that points to the next PCB in the ready queue.
- ↻ **Device Queue:** This queue consists of the processes that are waiting for a particular I/O device. Each device has its own device queue.

Representation of Process Scheduling

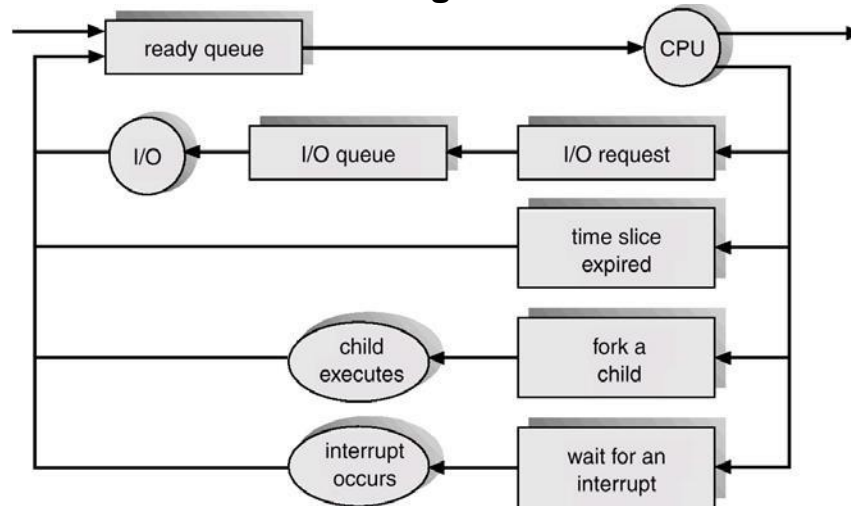

Schedulers

A **scheduler** is a decision maker that selects the processes from one scheduling queue to another or allocates CPU for execution. The Operating System has three types of scheduler:

1. Long-term scheduler or Job scheduler
2. Short-term scheduler or CPU scheduler
3. Medium-term scheduler

Long-term scheduler or Job scheduler

- The long-term scheduler or job scheduler selects processes from discs and loads them into main memory for execution. It executes much less frequently.
- It controls the degree of multiprogramming (i.e., the number of processes in memory).
- Because of the longer interval between executions, the long-term scheduler can afford to take more time to select a process for execution.

Short-term scheduler or CPU scheduler

- The short-term scheduler or CPU scheduler selects a process from among the processes that are ready to execute and allocates the CPU.
- The short-term scheduler must select a new process for the CPU frequently. A process may execute for only a few milliseconds before waiting for an I/O request.

Medium-term scheduler

The medium-term scheduler schedules the processes as intermediate level of scheduling

Processes can be described as either:

- ◆ I/O-bound process – spends more time doing I/O than computations, many short CPU bursts.
- ◆ CPU-bound process – spends more time doing computations; few very long CPU bursts.

Context Switch

- When CPU switches to another process, the system must save the state of the old process and load the saved state for the new process.
- Context-switch time is overhead; the system does no useful work while switching.

- Time dependent on hardware support.

Process Creation

Parent process create children processes, which, in turn create other processes, forming a tree of processes.

Resource sharing: ♦ Parent and children share all resources.

- ♦ Children share subset of parent's resources.
- ♦ Parent and child share no resources.

Execution: ♦ Parent and children execute concurrently.

- ♦ Parent waits until children terminate.

Address space: ♦ Child duplicate of parent.

- ♦ Child has a program loaded into it.

UNIX examples

- ♦ **fork** system call creates new process
- ♦ **exec** system call used after a **fork** to replace the process' memory space with a new program.

Process Termination

- Process executes last statement and asks the operating system to decide it (**exit**).
- ♦ Output data from child to parent (via **wait**).
- ♦ Process' resources are deallocated by operating system.
 - Parent may terminate execution of children processes (**abort**).
- ♦ Child has exceeded allocated resources.
- ♦ Task assigned to child is no longer required.
- ♦ Parent is exiting.
- ✓ Operating system does not allow child to continue if its parent terminates.
- ✓ Cascading termination.

Cooperating Processes

The concurrent processes executing in the operating system may be either independent processes or cooperating processes. A process is **independent** if it cannot affect or be affected by the other processes executing in the system. Clearly, any process that does not share any data (temporary or persistent) with any other process is independent. On the other hand, a process is **cooperating** if it can affect or be affected by the other processes executing in the system. Clearly, any process that shares data with other processes is a cooperating process.

Advantages of process cooperation

Information sharing: Since several users may be interested in the same piece of information (for instance, a shared file), we must provide an environment to allow concurrent access to these types of resources.

Computation speedup: If we want a particular task to run faster, we must break it into subtasks, each of which will be executing in parallel with the others. Such a speedup can be achieved only if the computer has multiple processing elements (such as CPUS or I/O channels).

Modularity: We may want to construct the system in a modular fashion, dividing the system functions into separate processes or threads

Convenience: Even an individual user may have many tasks on which to work at one time. For instance, a user may be editing, printing, and compiling in parallel.

Concurrent execution of cooperating processes requires mechanisms that allow processes to communicate with one another and to synchronize their actions.

Lecture #9,#10,#11,#12

CPU Scheduling

- Basic Concepts
- Scheduling Criteria
- Scheduling Algorithms
- Multiple-Processor Scheduling
- Real-Time Scheduling
- Algorithm Evaluation

Basic Concepts

- Maximum CPU utilization obtained with multiprogramming
- CPU-I/O Burst Cycle – Process execution consists of a *cycle* of CPU execution and I/O wait.
- CPU burst distribution

Alternating Sequence of CPU And I/O Bursts

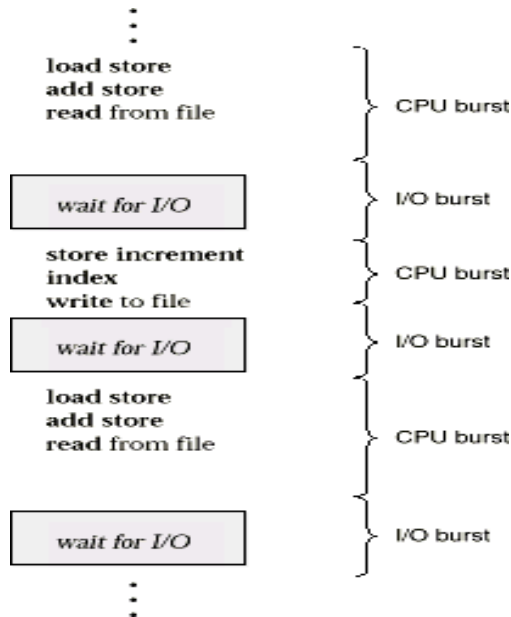

CPU Scheduler

- Selects from among the processes in memory that are ready to execute, and allocates the CPU to one of them.
- CPU scheduling decisions may take place when a process:
 1. Switches from running to waiting state.
 2. Switches from running to ready state.
 3. Switches from waiting to ready.
 4. Terminates.
- Scheduling under 1 and 4 is *non preemptive*.
- All other scheduling is *preemptive*.

Dispatcher

Dispatcher module gives control of the CPU to the process selected by the short-term scheduler; this involves:

- ♦ switching context

- ♦ switching to user mode
 - ♦ jumping to the proper location in the user program to restart that program
- Dispatch latency** – time it takes for the dispatcher to stop one process and start another running.

Scheduling Criteria

- **CPU utilization** – keep the CPU as busy as possible
- **Throughput** – # of processes that complete their execution per time unit
- **Turnaround time** – amount of time to execute a particular process
- **Waiting time** – amount of time a process has been waiting in the ready queue
- **Response time** – amount of time it takes from when a request was submitted until the first response is produced, **not** output (for time-sharing environment)

Optimization Criteria

- Max CPU utilization
- Max throughput
- Min turnaround time
- Min waiting time
- Min response time

First-Come, First-Served Scheduling

By far the simplest CPU-scheduling algorithm is the first-come, first-served (FCFS) scheduling algorithm. With this scheme, the process that requests the CPU first is allocated the CPU first. The implementation of the FCFS policy is easily managed with a FIFO queue. When a process enters the ready queue, its PCB is linked onto the tail of the queue. When the CPU is free, it is allocated to the process at the head of the queue. The running process is then removed from the queue. The code for FCFS scheduling is simple to write and understand. The average waiting time under the FCFS policy, however, is often quite long.

Consider the following set of processes that arrive at time 0, with the length of the CPU-burst time given in milliseconds:

Process	Burst Time
P1	24
P2	3
P3	3

If the processes arrive in the order P1, P2, P3, and are served in FCFS order, we get the result shown in the



following Gantt chart:

The waiting time is 0 milliseconds for process P1, 24 milliseconds for process P2, and 27 milliseconds for process P3. Thus, the average waiting time is $(0 + 24 + 27)/3 = 17$ milliseconds. If the processes arrive in the order P2, P3, P1, however, the results will be as shown in the following Gantt chart:



The average waiting time is now $(6 + 0 + 3)/3 = 3$ milliseconds. This reduction is substantial. Thus, the average waiting time under a FCFS policy is generally not minimal, and may vary substantially if the process CPU-burst times vary greatly.

In addition, consider the performance of FCFS scheduling in a dynamic situation. Assume we have one CPU-bound process and many I/O-bound processes. As the processes flow around the system, the following scenario may result. The CPU-bound process will get the CPU and hold it. During this time, all the other processes will finish their I/O and move into the ready queue, waiting for the CPU. While the processes wait in the ready queue, the I/O devices are idle. Eventually, the CPU-bound process finishes its CPU burst and moves to an I/O device. All the I/O-bound processes, which have very short CPU bursts, execute quickly and move back to the I/O queues. At this point, the CPU sits idle.

The CPU-bound process will then move back to the ready queue and be allocated the CPU. Again, all the I/O processes end up waiting in the ready queue until the CPU-bound process is done. There is a convoy effect, as all the other processes wait for the one big process to get off the CPU. This effect results in lower CPU and device utilization than might be possible if the shorter processes were allowed to go first.

The FCFS scheduling algorithm is non-preemptive. Once the CPU has been allocated to a process, that process keeps the CPU until it releases the CPU, either by terminating or by requesting I/O. The FCFS algorithm is particularly troublesome for time-sharing systems, where each user needs to get a share of the CPU at regular intervals. It would be disastrous to allow one process to keep the CPU for an extended period.

Shortest-Job-First Scheduling

A different approach to CPU scheduling is the shortest-job-first (SJF) scheduling algorithm. This algorithm associates with each process the length of the latter's next CPU burst. When the CPU is available, it is assigned to the process that has the smallest next CPU burst. If two processes have the same length next CPU burst, FCFS scheduling is used to break the tie. Note that a more appropriate term would be the shortest next CPU burst, because the scheduling is done by examining the length of the next CPU burst of a process, rather than its total length. We use the term SJF because most people and textbooks refer to this type of scheduling discipline as SJF.

As an example, consider the following set of processes, with the length of the CPU-burst time given in milliseconds:

Process	Burst Time
P1	6
p2	8
p3	7
p4	3

Using SJF scheduling, we would schedule these processes according to the following Gantt chart:

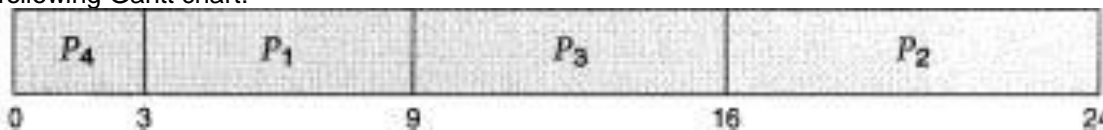

The waiting time is 3 milliseconds for process P1, 16 milliseconds for process P2, 9 milliseconds for process P3, and 0 milliseconds for process P4. Thus, the average waiting time is $(3 + 16 + 9 + 0)/4 = 7$ milliseconds. If we were using the FCFS scheduling scheme, then the average waiting time would be 10.25 milliseconds.

The SJF scheduling algorithm is provably optimal, in that it gives the minimum average waiting time for a given set of processes. By moving a short process before a long one, the waiting time of the short process decreases more than it increases the waiting time of the long process. Consequently, the average waiting time decreases.

The real difficulty with the SJF algorithm is knowing the length of the next CPU request. For long-term (or job) scheduling in a batch system, we can use as the length the process time limit that a user specifies when he submits the job.

Thus, users are motivated to estimate the process time limit accurately, since a lower value may mean faster response. (Too low a value will cause a time-limit exceeded error and require resubmission.) SJF scheduling is used frequently in long-term scheduling.

Although the SJF algorithm is optimal, it cannot be implemented at the level of short-term CPU scheduling. There is no way to know the length of the next CPU burst. One approach is to try to approximate SJF scheduling. We may not know the length of the next CPU burst, but we may be able to predict its value. We expect that the next CPU burst will be similar in length to the previous ones.

Thus, by computing an approximation of the length of the next CPU burst, we can pick the process with the shortest predicted CPU burst.

The SJF algorithm may be either preemptive or nonpreemptive. The choice arises when a new process arrives at the ready queue while a previous process is executing. The new process may have a shorter next CPU burst than what is left of the currently executing process. A preemptive SJF algorithm will preempt the currently executing process, whereas a nonpreemptive SJF algorithm will allow the currently running process to finish its CPU burst. Preemptive SJF scheduling is sometimes called shortest-remaining-time-first scheduling.

As an example, consider the following four processes, with the length of the CPU-burst time given in milliseconds:

Process	Arrival Time	Burst Time
P1	0	8
P2	1	4
P3	2	9
p4	3	5

If the processes arrive at the ready queue at the times shown and need the indicated burst times, then the resulting preemptive SJF schedule is as depicted in the following Gantt chart:

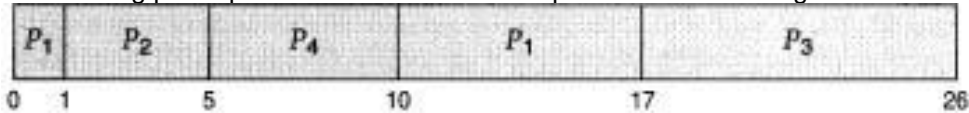

Process P1 is started at time 0, since it is the only process in the queue. Process P2 arrives at time 1. The remaining time for process P1 (7 milliseconds) is larger than the time required by process P2 (4 milliseconds), so process P1 is preempted, and process P2 is scheduled. The average waiting time for this example is $((10 - 1) + (1 - 1) + (17 - 2) + (5 - 3))/4 = 26/4 = 6.5$ milliseconds. A nonpreemptive SJF scheduling would result in an average waiting time of 7.75 milliseconds.

Priority Scheduling

The SJF algorithm is a special case of the general priority-scheduling algorithm. A priority is associated with each process, and the CPU is allocated to the process with the highest priority. Equal-priority processes are scheduled in FCFS order.

An SJF algorithm is simply a priority algorithm where the priority (p) is the inverse of the (predicted) next CPU burst. The larger the CPU burst, the lower the priority, and vice versa.

Note that we discuss scheduling in terms of high priority and low priority. Priorities are generally some fixed range of numbers, such as 0 to 7, or 0 to 4,095. However, there is no general agreement on whether 0 is the highest or lowest priority. Some systems use low numbers to represent low priority; others use low numbers for high priority. This difference can lead to confusion. In this text, we use low numbers to represent high priority. As an example, consider the following set of processes, assumed to have arrived at time 0, in the order P1, P2, ..., P_s, with the length of the CPU-burst time given in milliseconds:

Process	Burst	Time Priority
P1	10	3
p2	1	1
p3	2	4
P4	1	5
P5	5	2

Using priority scheduling, we would schedule these processes according to the following Gantt chart:



The average waiting time is 8.2 milliseconds. Priorities can be defined either internally or externally. Internally defined priorities use some measurable quantity or quantities to compute the priority of a process.

For example, time limits, memory requirements, the number of open files, and the ratio of average I/O burst to average CPU burst have been used in computing priorities. External priorities are set by criteria that are external to the operating system, such as the importance of the process, the type and amount of funds being paid for computer use, the department sponsoring the work, and other, often political, factors.

Priority scheduling can be either preemptive or nonpreemptive. When a process arrives at the ready queue, its priority is compared with the priority of the currently running process. A preemptive priority-scheduling algorithm will preempt the CPU if the priority of the newly arrived process is higher than the priority of the currently running process. A nonpreemptive priority-scheduling algorithm will simply put the new process at the head of the ready queue.

A major problem with priority-scheduling algorithms is indefinite blocking (or starvation). A process that is ready to run but lacking the CPU can be considered blocked-waiting for the CPU. A priority-scheduling algorithm can leave some low-priority processes waiting indefinitely for the CPU.

A solution to the problem of indefinite blockage of low-priority processes is aging. Aging is a technique of gradually increasing the priority of processes that wait in the system for a long time. For example, if priorities range from 127 (low) to 0 (high), we could decrement the priority of a waiting process by 1 every 15 minutes. Eventually, even a process with an initial priority of 127 would have the highest priority in the system and would be executed. In fact, it would take no more than 32 hours for a priority 127 process to age to a priority 0 process.

Round-Robin Scheduling

The round-robin (RR) scheduling algorithm is designed especially for timesharing systems. It is similar to FCFS scheduling, but preemption is added to switch between processes. A small unit of time, called a time quantum (or time slice), is defined. A time quantum is generally from 10 to 100 milliseconds. The ready queue is treated as a circular queue. The CPU scheduler goes around the ready queue, allocating the CPU to each process for a time interval of up to 1 time quantum.

To implement RR scheduling, we keep the ready queue as a FIFO queue of processes. New processes are added to the tail of the ready queue. The CPU scheduler picks the first process from the ready queue, sets a timer to interrupt after 1 time quantum, and dispatches the process.

One of two things will then happen. The process may have a CPU burst of less than 1 time quantum. In this case, the process itself will release the CPU voluntarily. The scheduler will then proceed to the next process in the ready queue. Otherwise, if the CPU burst of the currently running process is longer than 1 time quantum, the timer will go off and will cause an interrupt to the operating system. A context switch will be executed, and the process will be put at the tail of the ready queue. The CPU scheduler will then select the next process in the ready queue.

The average waiting time under the RR policy, however, is often quite long.

Consider the following set of processes that arrive at time 0, with the length of the CPU-burst time given in milliseconds:

Process	Burst Time
P1	24
P2	3
P3	3

If we use a time quantum of 4 milliseconds, then process P1 gets the first 4 milliseconds. Since it requires another 20 milliseconds, it is preempted after the first time quantum, and the CPU is given to the next process in the queue, process P2. Since process P2 does not need 4 milliseconds, it quits before its time quantum expires. The CPU is then given to the next process, process P3. Once each process has received 1 time quantum, the CPU is returned to process P1 for an additional time quantum. The resulting RR schedule is

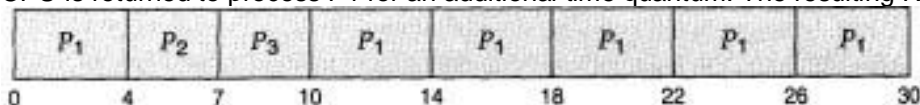

The average waiting time is $17/3 = 5.66$ milliseconds.

In the RR scheduling algorithm, no process is allocated the CPU for more than 1 time quantum in a row. If a process' CPU burst exceeds 1 time quantum, that process is preempted and is put back in the ready queue. The RR scheduling algorithm is preemptive.

If there are n processes in the ready queue and the time quantum is q , then each process gets $1/n$ of the CPU time in chunks of at most q time units. Each process must wait no longer than $(n - 1) \times q$ time units until its next time quantum. For example, if there are five processes, with a time quantum of 20 milliseconds, then each process will get up to 20 milliseconds every 100 milliseconds.

The performance of the RR algorithm depends heavily on the size of the time quantum. At one extreme, if the time quantum is very large (infinite), the RR policy is the same as the FCFS policy. If the time quantum is very small (say 1 microsecond), the RR approach is called processor sharing, and appears (in theory) to the users as though each of n processes has its own processor running at $1/n$ the speed of the real processor. This approach was used in Control Data Corporation (CDC) hardware to implement 10 peripheral processors with only one set of hardware and 10 sets of registers. The hardware executes one instruction for one set of registers, then goes on to the next. This cycle continues, resulting in 10 slow processors rather than one fast processor.

Multilevel Queue Scheduling

Another class of scheduling algorithms has been created for situations in which processes are easily classified into different groups. For example, a common division is made between foreground (or interactive)

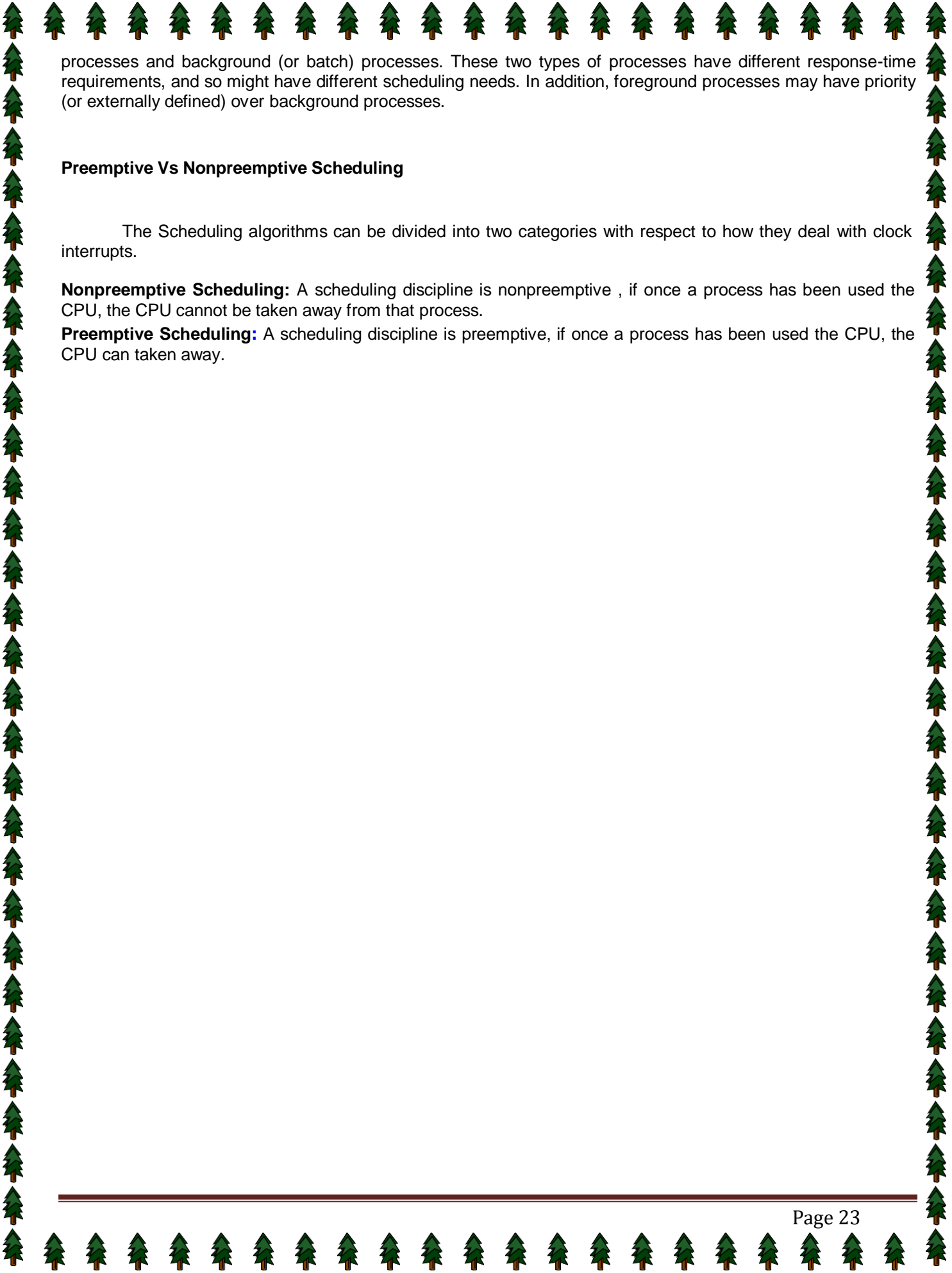

processes and background (or batch) processes. These two types of processes have different response-time requirements, and so might have different scheduling needs. In addition, foreground processes may have priority (or externally defined) over background processes.

Preemptive Vs Nonpreemptive Scheduling

The Scheduling algorithms can be divided into two categories with respect to how they deal with clock interrupts.

Nonpreemptive Scheduling: A scheduling discipline is nonpreemptive , if once a process has been used the CPU, the CPU cannot be taken away from that process.

Preemptive Scheduling: A scheduling discipline is preemptive, if once a process has been used the CPU, the CPU can be taken away.

Lecture #13.#14

Thread

A thread, sometimes called a lightweight process (LWP), is a basic unit of CPU utilization; it comprises a thread ID, a program counter, a register set, and a stack. It shares with other threads belonging to the same process its code section, data section, and other operating-system resources, such as open files and signals. A traditional (or heavyweight) process has a single thread of control. If the process has multiple threads of control, it can do more than one task at a time.

Motivation

Many software packages that run on modern desktop PCs are multithreaded. An application typically is implemented as a separate process with several thread of control.

Single-threaded and multithreaded

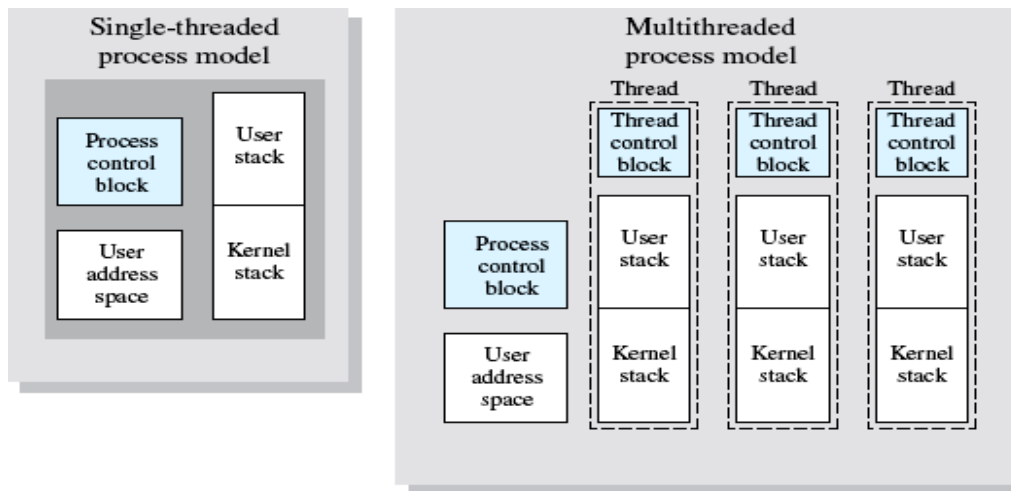

Ex: A web browser might have one thread display images or text while another thread retrieves data from the network. A word processor may have a thread for displaying graphics, another thread for reading keystrokes from the user, and a third thread for performing spelling and grammar checking in the background.

In certain situations a single application may be required to perform several similar tasks. For example, a web server accepts client requests for web pages, images, sound, and so forth. A busy web server may have several (perhaps hundreds) of clients concurrently accessing it. If the web server ran as a traditional single-threaded process, it would be able to service only one client at a time.

One solution is to have the server run as a single process that accepts requests. When the server receives a request, it creates a separate process to service that request. In fact, this process-creation method was in common use before threads became popular. Process creation is very heavyweight, as was shown in the previous chapter. If the new process will perform the same tasks as the existing process, why incur all that overhead? It is generally more efficient for one process that contains multiple threads to serve the same purpose. This approach would multithread the web-server process. The server would create a separate thread that would listen for client requests; when a request was made, rather than creating another process, it would create another thread to service the request.

Threads also play a vital role in remote procedure call (RPC) systems. RPCs allow inter-process communication by providing a communication mechanism similar to ordinary function or procedure calls. Typically, RPC servers are multithreaded. When a server receives a message, it services the message using a separate thread. This allows the server to service several concurrent requests.

Benefits

The benefits of multithreaded programming can be broken down into four major categories:

1. Responsiveness: Multithreading an interactive application may allow a program to continue running even if part of it is blocked or is performing a lengthy operation, thereby increasing responsiveness to the user. For instance, a multithreaded web browser could still allow user interaction in one thread while an image is being loaded in another thread.

2. Resource sharing: By default, threads share the memory and the resources of the process to which they belong. The benefit of code sharing is that it allows an application to have several different threads of activity all within the same address space.

3. Economy: Allocating memory and resources for process creation is costly. Alternatively, because threads share resources of the process to which they belong, it is more economical to create and context switch threads. It can be difficult to gauge empirically the difference in overhead for creating and maintaining a process rather than a thread, but in general it is much more time consuming to create and manage processes than threads. In Solaris 2, creating a process is about 30 times slower than is creating a thread, and context switching is about five times slower.

4. Utilization of multiprocessor architectures: The benefits of multithreading can be greatly increased in a multiprocessor architecture, where each thread may be running in parallel on a different processor. A single-threaded process can only run on one CPU, no matter how many are available.

Multithreading on a multi-CPU machine increases concurrency. In a single processor architecture, the CPU generally moves between each thread so quickly as to create an illusion of parallelism, but in reality only one thread is running at a time.

The OS supports the threads that can be provided in following two levels:

User-Level Threads

User-level threads implement in user-level libraries, rather than via systems calls, so thread switching does not need to call operating system and to cause interrupt to the kernel. In fact, the kernel knows nothing about user-level threads and manages them as if they were single-threaded processes.

Advantages:

- User-level threads do not require modification to operating systems.
- Simple Representation: Each thread is represented simply by a PC, registers, stack and a small control block, all stored in the user process address space.
- Simple Management: This simply means that creating a thread, switching between threads and synchronization between threads can all be done without intervention of the kernel.
- Fast and Efficient: Thread switching is not much more expensive than a procedure call.

Disadvantages:

- There is a lack of coordination between threads and operating system kernel.
- User-level threads require non-blocking systems call i.e., a multithreaded kernel.

Kernel-Level Threads

In this method, the kernel knows about and manages the threads. Instead of thread table in each process, the kernel has a thread table that keeps track of all threads in the system. Operating Systems kernel provides system call to create and manage threads.

Advantages:

- Because kernel has full knowledge of all threads, Scheduler may decide to give more time to a process having large number of threads than process having small number of threads.
- Kernel-level threads are especially good for applications that frequently block.

Disadvantages:

- The kernel-level threads are slow and inefficient. For instance, threads operations are hundreds of times slower than that of user-level threads.

Since kernel must manage and schedule threads as well as processes. It requires a full thread control block (TCB) for each thread to maintain information about threads. As a result there is significant overhead and increased in kernel complexity.

Multithreading Models

Many systems provide support for both user and kernel threads, resulting in different multithreading models. We look at three common types of threading implementation.

Many-to-One Model

The many-to-one model maps many user-level threads to one kernel thread. Thread management is done in user space, so it is efficient, but the entire process will block if a thread makes a blocking system call. Also, because only one thread can access the kernel at a time, multiple threads are unable to run in parallel on multiprocessors.

One-to-one Model

The one-to-one model maps each user thread to a kernel thread. It provides more concurrency than the many-to-one model by allowing another thread to run when a thread makes a blocking system call; it also allows multiple threads to run in parallel on multiprocessors. The only drawback to this model is that creating a user thread requires creating the corresponding kernel thread. Because the overhead of creating kernel threads can burden the performance of an application, most implementations of this model restrict the number of threads supported by the system. Windows NT, Windows 2000, and OS/2 implement the one-to-one model.

Many-to-Many Model

The many-to-many model multiplexes many user-level threads to a smaller or equal number of kernel threads. The number of kernel threads may be specific to either a particular application or a particular machine (an application may be allocated more kernel threads on a multiprocessor than on a uniprocessor). Whereas the many-to-one model allows the developer to create as many user threads as she wishes, true concurrency is not gained because the kernel can schedule only one thread at a time. The one-to-one model allows for greater concurrency, but the developer has to be careful not to create too many threads within an application (and in some instances may be limited in the number of threads she can create). The many-to-many model suffers from neither of these shortcomings: Developers can create as many user threads as necessary, and the corresponding kernel threads can run in parallel on a multiprocessor.

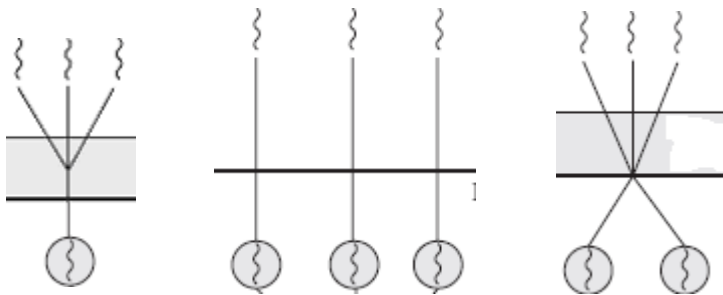

(Diagram of many-to-one model, one-to-one model and many-to-many model)

Process vs. Thread

Process	Thread
1.Process cannot share the same memory area(address space)	1.Threads can share memory and files.
2.It takes more time to create a process	2.It takes less time to create a thread.
3.It takes more time to complete the execution and terminate.	3.Less time to terminate.
4.Execution is very slow.	4.Execution is very fast.
5.It takes more time to switch between two processes.	5.It takes less time to switch between two threads.
6.System calls are required to communicate each other	6.System calls are not required.
7.It requires more resources to execute.	7.Requires fewer resources.
8.Implementing the communication between processes is bit more difficult.	8.Communication between two threads are very easy to implement because threads share the memory

Lecture #15

Inter-process Communication (IPC)

- Mechanism for processes to communicate and to synchronize their actions.
- Message system – processes communicate with each other without resorting to shared variables.
- IPC facility provides two operations:
 1. **send**(*message*) – message size fixed or variable
 2. **receive**(*message*)
- If *P* and *Q* wish to communicate, they need to:
 1. establish a *communication link* between them
 2. exchange messages via send/receive
- Implementation of communication link
 1. physical (e.g., shared memory, hardware bus)
 2. logical (e.g., logical properties)

Direct Communication

Processes must name each other explicitly:

- ◆ **send** (*P*, *message*) – send a message to process *P*
- ◆ **receive**(*Q*, *message*) – receive a message from process *Q* Properties of communication link
- ◆ Links are established automatically.
- ◆ A link is associated with exactly one pair of communicating processes.
- ◆ Between each pair there exists exactly one link.
- ◆ The link may be unidirectional, but is usually bi-directional.

Indirect Communication

Messages are directed and received from mailboxes (also referred to as ports).

- ◆ Each mailbox has a unique id.
- ◆ Processes can communicate only if they share a mailbox.

Properties of communication link

- ◆ Link established only if processes share a common mailbox
- ◆ A link may be associated with many processes.
- ◆ Each pair of processes may share several communication links.
- ◆ Link may be unidirectional or bi-directional.

Operations

- ◆ create a new mailbox
- ◆ send and receive messages through mailbox
- ◆ destroy a mailbox

Primitives are defined as:

send(*A*, *message*) – send a message to mailbox *A*

receive(*A*, *message*) – receive a message from mailbox *A*

Mailbox sharing

- ◆ *P1*, *P2*, and *P3* share mailbox *A*.
- ◆ *P1*, sends; *P2* and *P3* receive.
- ◆ Who gets the message?

Solutions

- ◆ Allow a link to be associated with at most two processes.
- ◆ Allow only one process at a time to execute a receive operation.
- ◆ Allow the system to select arbitrarily the receiver. Sender is notified who the receiver was.

Concurrent Processes

The concurrent processes executing in the operating system may be either independent processes or cooperating processes. A process is independent if it cannot affect or be affected by the other processes executing in the system. Clearly, any process that does not share any data (temporary or persistent) with any other process is independent. On the other hand, a process is cooperating if it can affect or be affected by the





other processes executing in the system. Clearly, any process that shares data with other processes is a cooperating process.

We may want to provide an environment that allows process cooperation for several reasons:

Information sharing: Since several users may be interested in the same piece of information (for instance, a shared file), we must provide an environment to allow concurrent access to these types of resources.

Computation speedup: If we want a particular task to run faster, we must break it into subtasks, each of which will be executing in parallel with the others. Such a speedup can be achieved only if the computer has multiple processing elements (such as CPUs or I/O channels).

Modularity: We may want to construct the system in a modular fashion, dividing the system functions into separate processes or threads.

Convenience: Even an individual user may have many tasks on which to work at one time. For instance, a user may be editing, printing, and compiling in parallel.





Lecture # 16

Message-Passing System

The function of a message system is to allow processes to communicate with one another without the need to resort to shared data. We have already seen message passing used as a method of communication in microkernels. In this scheme, services are provided as ordinary user processes. That is, the services operate outside of the kernel. Communication among the user processes is accomplished through the passing of messages. An IPC facility provides at least the two operations: send (message) and receive (message).

Messages sent by a process can be of either fixed or variable size. If only fixed-sized messages can be sent, the system-level implementation is straightforward. This restriction, however, makes the task of programming more difficult. On the other hand, variable-sized messages require a more complex system-level implementation, but the programming task becomes simpler.

If processes P and Q want to communicate, they must send messages to and receive messages from each other; a communication link must exist between them. This link can be implemented in a variety of ways. We are concerned here not with the link's physical implementation, but rather with its logical implementation. Here are several methods for logically implementing a link and the send/receive operations:

- Direct or indirect communication
- Symmetric or asymmetric communication
- Automatic or explicit buffering
- Send by copy or send by reference
- Fixed-sized or variable-sized messages

We look at each of these types of message systems next.

Synchronization

Communication between processes takes place by calls to send and receive primitives. There are different design options for implementing each primitive. Message passing may be either blocking or nonblocking-also known as synchronous and asynchronous.

Blocking send: The sending process is blocked until the message is received by the receiving process or by the mailbox.

Nonblocking send: The sending process sends the message and resumes operation.

Blocking receive: The receiver blocks until a message is available.

Nonblocking receive: The receiver retrieves either a valid message or a null.

Different combinations of send and receive are possible. When both the send and receive are blocking, we have a rendezvous between the sender and the receiver.

Buffering

Whether the communication is direct or indirect, messages exchanged by communicating processes reside in a temporary queue. Basically, such a queue can be implemented in three ways:

Zero capacity: The queue has maximum length 0; thus, the link cannot have any messages waiting in it. In this case, the sender must block until the recipient receives the message.

Bounded capacity: The queue has finite length n ; thus, at most n messages can reside in it. If the queue is not full when a new message is sent, the latter is placed in the queue (either the message is copied or a pointer to the message is kept), and the sender can continue execution without waiting. The link has a finite capacity, however. If the link is full, the sender must block until space is available in the queue.

Unbounded capacity: The queue has potentially infinite length; thus, any number of messages can wait in it. The sender never blocks. The zero-capacity case is sometimes referred to as a message system with no buffering; the other cases are referred to as automatic buffering.

Client-Server Communication

- Sockets
- Remote Procedure Calls
- Remote Method Invocation (Java)

Lecture # 17

Process Synchronization

A situation where several processes access and manipulate the same data concurrently and the outcome of the execution depends on the particular order in which the access takes place, is called a **race condition**.

Producer-Consumer Problem

Paradigm for cooperating processes, *producer* process produces information that is consumed by a *consumer* process.

To allow producer and consumer processes to run concurrently, we must have available a buffer of items that can be filled by the producer and emptied by the consumer. A producer can produce one item while the consumer is consuming another item. The producer and consumer must be synchronized, so that the consumer does not try to consume an item that has not yet been produced. In this situation, the consumer must wait until an item is produced.

- ◆ *unbounded-buffer* places no practical limit on the size of the buffer.
- ◆ *bounded-buffer* assumes that there is a fixed buffer size.

Bounded-Buffer – Shared-Memory Solution

The consumer and producer processes share the following variables.

Shared data

```
#define BUFFER_SIZE 10
typedef struct
{
    ...
} item;
item buffer[BUFFER_SIZE];
int in = 0;
int out = 0;
```

Solution is correct, but can only use `BUFFER_SIZE-1` elements.

The shared buffer is implemented as a circular array with two logical pointers: `in` and `out`. The variable `in` points to the next free position in the buffer; `out` points to the first full position in the buffer. The buffer is empty when `in == out`; the buffer is full when `((in + 1) % BUFFERSIZE) == out`.

The code for the producer and consumer processes follows. The producer process has a local variable `nextProduced` in which the new item to be produced is stored:

Bounded-Buffer – Producer Process

```
item nextProduced;
while (1)
{
    while (((in + 1) % BUFFER_SIZE) == out)
        /* do nothing */
    buffer[in] = nextProduced;
    in = (in + 1) % BUFFER_SIZE;
}
```

Bounded-Buffer – Consumer Process

```
item nextConsumed;
```



```
while (1)
{
while (in == out)
; /* do nothing */
nextConsumed = buffer[out];
out = (out + 1) % BUFFER_SIZE;
}
```

The critical section problem

Consider a system consisting of n processes $\{P_0, P_1, \dots, P_{n-1}\}$. Each process has a segment of code, called a **critical section**, in which the process may be changing common variables, updating a table, writing a file, and so on. The important feature of the system is that, when one process is executing in its critical section, no other process is to be allowed to execute in its critical section. Thus, the execution of critical sections by the processes is **mutually exclusive** in time. The critical-section problem is to design a protocol that the processes can use to cooperate. Each process must request permission to enter its critical section. The section of code implementing this request is the entry section. The critical section may be followed by an exit section. The remaining code is the remainder section.

```
do{
    Entry section
        Critical section
    Exit section
        Remainder section
}while(1);
```

A solution to the critical-section problem must satisfy the following three requirements:

- 1. Mutual Exclusion:** If process P_i is executing in its critical section, then no other processes can be executing in their critical sections.
- 2. Progress:** If no process is executing in its critical section and some processes wish to enter their critical sections, then only those processes that are not executing in their remainder section can participate in the decision on which will enter its critical section next, and this selection cannot be postponed indefinitely.
- 3. Bounded Waiting:** There exists a bound on the number of times that other processes are allowed to enter their critical sections after a process has made a request to enter its critical section and before that request is granted.

Lecture # 18

Peterson's solution

Peterson's solution is a software based solution to the critical section problem.

Consider two processes P0 and P1. For convenience, when presenting P_i , we use P_i to denote the other process; that is, $j == 1 - i$.

The processes share two variables:

```
boolean flag [2];
```

```
int turn;
```

Initially $flag[0] = flag[1] = false$, and the value of $turn$ is immaterial (but is either 0 or 1). The structure of process P_i is shown below.

```
do{
```

```
    flag[i]=true
```

```
    turn=j
```

```
    while(flag[j] && turn==j);
```

```
        critical section
```

```
    flag[i]=false
```

```
        Remainder section
```

```
}while(1);
```

To enter the critical section, process P_i first sets $flag[i]$ to be true and then sets $turn$ to the value j , thereby asserting that if the other process wishes to enter the critical section it can do so. If both processes try to enter at the same time, $turn$ will be set to both i and j at roughly the same time. Only one of these assignments will last; the other will occur, but will be overwritten immediately. The eventual value of $turn$ decides which of the two processes is allowed to enter its critical section first.

We now prove that this solution is correct. We need to show that:

1. Mutual exclusion is preserved,
2. The progress requirement is satisfied,
3. The bounded-waiting requirement is met.

To prove property 1, we note that each P_i enters its critical section only if either $flag[j] == false$ or $turn == i$. Also note that, if both processes can be executing in their critical sections at the same time, then $flag[i] == flag[j] == true$. These two observations imply that P_0 and P_1 could not have successfully executed their while statements at about the same time, since the value of $turn$ can be either 0 or 1, but cannot be both. Hence, one of the processes say P_j must have successfully executed the while statement, whereas P_i had to execute at least one additional statement (" $turn == j$ "). However, since, at that time, $flag[j] == true$, and $turn == j$, and this condition will persist as long as P_i is in its critical section, the result follows:

To prove properties 2 and 3, we note that a process P_i can be prevented from entering the critical section only if it is stuck in the while loop with the condition $flag[j] == true$ and $turn == j$; this loop is the only one. If P_i is not ready to enter the critical section, then $flag[j] == false$ and P_i can enter its critical section. If P_i has set $flag[j]$ to true and is also executing in its while statement, then either $turn == i$ or $turn == j$. If $turn == i$, then P_i will enter the critical section. If $turn == j$, then P_i will enter the critical section. However, once P_i exits its critical section, it will reset $flag[j]$ to false, allowing P_i to enter its critical section. If P_i resets $flag[j]$ to true, it must also set $turn$ to i .

Thus, since P_i does not change the value of the variable $turn$ while executing the while statement, P_i will enter the critical section (progress) after at most one entry by P_i (bounded waiting).

Lecture # 19

Synchronization Hardware

As with other aspects of software, hardware features can make the programming task easier and improve system efficiency. In this section, we present some simple hardware instructions that are available on many systems, and show how they can be used effectively in solving the critical-section problem.

The definition of the TestAndSet instruction.

```
boolean TestAndSet(boolean &target)
{
    boolean rv = target;
    target = true;
    return rv;
}
```

The critical-section problem could be solved simply in a uniprocessor environment if we could forbid interrupts to occur while a shared variable is being modified. In this manner, we could be sure that the current sequence of instructions would be allowed to execute in order without preemption. No other instructions would be run, so no unexpected modifications could be made to the shared variable.

Unfortunately, this solution is not feasible in a multiprocessor environment. Disabling interrupts on a multiprocessor can be time-consuming, as the message is passed to all the processors. This message passing delays entry into each critical section, and system efficiency decreases. Also, consider the effect on a system's clock, if the clock is kept updated by interrupts.

Many machines therefore provide special hardware instructions that allow us either to test and modify the content of a word, or to swap the contents of two words, atomically—that is, as one uninterruptible unit. We can use these special instructions to solve the critical-section problem in a relatively simple manner. Rather than discussing one specific instruction for one specific machine, let us abstract the main concepts behind these types of instructions.

The TestAndSet instruction can be defined as shown in code. The important characteristic is that this instruction is executed atomically. Thus, if two TestAndSet instructions are executed simultaneously (each on a different CPU), they will be executed sequentially in some arbitrary order.

Mutual-exclusion implementation with **TestAndSet**

```
do{
```

```
    while(TestAndSet(lock));
        critical section
    lock=false
    Remainder section
```

```
}while(1);
```

```
void Swap(boolean &a, boolean &b) {
    boolean temp = a;
    a = b;
    b = temp;
}
```

If the machine supports the TestAndSet instruction, then we can implement mutual exclusion by declaring a Boolean variable lock, initialized to false.

If the machine supports the Swap instruction, then mutual exclusion can be provided as follows. A global Boolean variable lock is declared and is initialized to false. In addition, each process also has a local Boolean variable key.

Lecture # 20

Semaphores

The solutions to the critical-section problem presented before are not easy to generalize to more complex problems. To overcome this difficulty, we can use a synchronization tool called a semaphore. A **semaphore** S is an integer variable that, apart from initialization, is accessed only through two standard atomic operations: **wait** and **signal**. These operations were originally termed P (for wait; from the Dutch *proberen*, to test) and V (for signal; from *verhogen*, to increment). The classical definition of wait in pseudocode is

```
wait(S) {
while (S <= 0)
; // no-op
S --;
}
```

The classical definitions of signal in pseudocode is

```
Signal(S){
S++;
}
```

Modifications to the integer value of the semaphore in the wait and signal operations must be executed indivisibly. That is, when one process modifies the semaphore value, no other process can simultaneously modify that same semaphore value. In addition, in the case of the wait (S), the testing of the integer value of S ($S \leq 0$), and its possible modification ($S--$), must also be executed without interruption.

Usage

We can use semaphores to deal with the n -process critical-section problem. The n processes share a semaphore, mutex (standing for mutual exclusion), initialized to 1. Each process P_i is organized as shown in Figure. We can also use semaphores to solve various synchronization problems.

For example, consider two concurrently running processes: P_1 with a statement S_1 and P_2 with a statement S_2 . Suppose that we require that S_2 be executed only after S_1 has completed. We can implement this scheme readily by letting P_1 and P_2 share a common semaphore $synch$, initialized to 0, and by inserting the statements in process P_1 , and the statements

```
wait (synch) ;
s2;
```

in process P_2 . Because $synch$ is initialized to 0, P_2 will execute S_2 only after P_1 has invoked $signal (synch)$, which is after S_1 .

```
s1;
signal (synch) ;
do {
    wait (mutex) ;
        critical section
    signal (mutex) ;
        remainder section
}
```

```
while (1);
Mutual-exclusion implementation with semaphores.
```

Implementation

The main disadvantage of the mutual-exclusion solutions and of the semaphore definition given here, is that they all require busy waiting. While a process is in its critical section, any other process that tries to enter its



critical section must loop continuously in the entry code. This continual looping is clearly a problem in a real multiprogramming system, where a single CPU is shared among many processes. Busy waiting wastes CPU cycles that some other process might be able to use productively. This type of semaphore is also called a spinlock (because the process "spins" while waiting for the lock). Spinlocks are useful in multiprocessor systems. The advantage of a spinlock is that no context switch is required when a process must wait on a lock, and a context switch may take considerable time. Thus, when locks are expected to be held for short times, spinlocks are useful.

To overcome the need for busy waiting, we can modify the definition of the wait and signal semaphore operations. When a process executes the wait operation and finds that the semaphore value is not positive, it must wait. However, rather than busy waiting, the process can block itself. The block operation places a process into a waiting queue associated with the semaphore, and the state of the process is switched to the waiting state. Then, control is transferred to the CPU scheduler, which selects another process to execute.

A process that is blocked, waiting on a semaphore S, should be restarted when some other process executes a signal operation. The process is restarted by a wakeup operation, which changes the process from the waiting state to the ready state. The process is then placed in the ready queue. (The CPU may or may not be switched from the running process to the newly ready process, depending on the CPU-scheduling algorithm.)

To implement semaphores under this definition, we define a semaphore as a "C" struct:

```
typedef struct {
    int value ;
    struct process *L;
} semaphore;
```

Each semaphore has an integer value and a list of processes. When a process must wait on a semaphore, it is added to the list of processes. A signal operation removes one process from the list of waiting processes and awakens that process.

The wait semaphore operation can now be defined as

```
void wait(semaphore S) {
    S.value--;
    if (S.value < 0) {
        add this process to S . L;
        block();
    }
}
```

The signal semaphore operation can now be defined as

```
void signal(semaphore S) {
    S.value++;
    if (S.value <= 0) {
        remove a process P from S . L ;
        wakeup (P) ;
    }
}
```

The block operation suspends the process that invokes it. The wakeup(P1) operation resumes the execution of a blocked process P. These two operations are provided by the operating system as basic system calls.

Binary Semaphores

The semaphore construct described in the previous sections is commonly known as a counting semaphore, since its integer value can range over an unrestricted domain. A binary semaphore is a semaphore with an integer value that can range only between 0 and 1. A binary semaphore can be simpler to implement than a counting semaphore, depending on the underlying hardware architecture. We will now show how a counting semaphore can be implemented using binary semaphores. Let S be a counting semaphore.

To implement it in terms of binary semaphores we need the following data structures:

```
binary-semaphore S1, S2;
```



```
int C;
```

Initially $S1 = 1$, $S2 = 0$, and the value of integer C is set to the initial value of the counting semaphore S .

The wait operation on the counting semaphore S can be implemented as follows:

```
wait (S1) ;
C--;
if (C < 0) {
    signal(S1);
    wait (S2) ;
}
signal(S1);
```

The signal operation on the counting semaphore S can be implemented as follows:

```
wait (S1) ;
C++;
if (C <= 0)
    signal (S2) ;
else
    signal (S1) ;
```

Classic Problems of Synchronization

We present a number of different synchronization problems as examples for a large class of concurrency-control problems. These problems are used for testing nearly every newly proposed synchronization scheme. Semaphores are used for synchronization in our solutions.

The Bounded-Buffer Problem

The bounded-buffer problem is commonly used to illustrate the power of synchronization primitives. We present here a general structure of this scheme, without committing ourselves to any particular implementation. We assume that the pool consists of n buffers, each capable of holding one item. The mutex semaphore provides mutual exclusion for accesses to the buffer pool and is initialized to the value 1. The empty and full semaphores count the number of empty and full buffers, respectively. The semaphore empty is initialized to the value n ; the semaphore full is initialized to the value 0.

The code for the producer process is

```
do{
    produce an item in nextp
    ...
    wait (empty) ;
    wait (mutex) ;
    ...
    add nextp to buffer
    ...
    signal(mutex);
    signal (full) ;
} while (1);
```

The code for the consumer process is

```
do{
    wait (full) ;
    wait (mutex) ;
    ...
```



```
remove an item from buffer to nextc
```

```
...  
signal (mutex) ;  
signal (empty) ;  
...  
consume the item in nextc  
...  
) while (1);
```

Note the symmetry between the producer and the consumer. We can interpret this code as the producer producing full buffers for the consumer, or as the consumer producing empty buffers for the producer.

Lecture # 22

The Readers- Writers Problem

A data object (such as a file or record) is to be shared among several concurrent processes. Some of these processes may want only to read the content of the shared object, whereas others may want to update (that is, to read and write) the shared object. We distinguish between these two types of processes by referring to those processes that are interested in only reading as readers, and to the rest as writers. Obviously, if two readers access the shared data object simultaneously, no adverse effects will result. However, if a writer and some other process (either a reader or a writer) access the shared object simultaneously, chaos may ensue.

To ensure that these difficulties do not arise, we require that the writers have exclusive access to the shared object. This synchronization problem is referred to as the readers-writers problem. Since it was originally stated, it has been used to test nearly every new synchronization primitive. The readers-writers problem has several variations, all involving priorities. The simplest one, referred to as the first readers-writers problem, requires that no reader will be kept waiting unless a writer has already obtained permission to use the shared object. In other words, no reader should wait for other readers to finish simply because a writer is waiting. The second readers-writers problem requires that, once a writer is ready, that writer performs its write as soon as possible. In other words, if a writer is waiting to access the object, no new readers may start reading.

A solution to either problem may result in starvation. In the first case, writers may starve; in the second case, readers may starve. For this reason, other variants of the problem have been proposed. In this section, we present a solution to the first readers-writers problem.

In the solution to the first readers-writers problem, the reader processes share the following data structures:

```
semaphore mutex, wrt;  
int readcount;
```

The semaphores `mutex` and `wrt` are initialized to 1; `readcount` is initialized to 0. The semaphore `wrt` is common to both the reader and writer processes. The `mutex` semaphore is used to ensure mutual exclusion when the variable `readcount` is updated. The `readcount` variable keeps track of how many processes are currently reading the object. The semaphore `wrt` functions as a mutual-exclusion semaphore for the writers. It is also used by the first or last reader that enters or exits the critical section. It is not used by readers who enter or exit while other readers are in their critical sections.

The code for a writer process is

```
do{  
wait (wrt) ;  
...  
writing is performed  
...  
signal(wrt);  
}while(1);
```

The code for a reader process is

```

do{
wait (mutex) ;
readcount++;
if (readcount == 1)
wait (wrt) ;
signal (mutex) ;
...
reading is performed
...
wait (mutex) ;
readcount--;
if (readcount == 0)
signal(wrt1);
signal (mutex) ;
}while(1);

```

Note that, if a writer is in the critical section and n readers are waiting, then one reader is queued on wrt, and n - 1 readers are queued on mutex. Also observe that, when a writer executes signal (wrt), we may resume the execution of either the waiting readers or a single waiting writer.

Lecture #23

The Dining-Philosophers Problem

Consider five philosophers who spend their lives thinking and eating. The philosophers share a common circular table surrounded by five chairs, each belonging to one philosopher. In the center of the table is a bowl of rice, and the table is laid with five single chopsticks. When a philosopher thinks, she does not interact with her colleagues. From time to time, a philosopher gets hungry and tries to pick up the two chopsticks that are closest to her (the chopsticks that are between her and her left and right neighbors). A philosopher may pick up only one chopstick at a time. Obviously, she cannot pick up a chopstick that is already in the hand of a neighbor. When a hungry philosopher has both her chopsticks at the same time, she eats without releasing her chopsticks. When she is finished eating, she puts down both of her chopsticks and starts thinking again.

The structure of philosopher i

```

do {
wait (chopstick[i] );
wait (chopstick[(i+1) % 5] );
...
eat
...
signal (chopstick [i] );
signal(chopstick[(i+1) % 5] );
...
think
...
) while (1);
.

```

The dining-philosophers problem is considered a classic synchronization problem, neither because of its practical importance nor because computer scientists dislike philosophers, but because it is an example of a large class of concurrency-control problems. It is a simple representation of the need to allocate several resources among several processes in a deadlock- and starvation free manner.

One simple solution is to represent each chopstick by a semaphore. A philosopher tries to grab the chopstick by executing a wait operation on that semaphore; she releases her chopsticks by executing the signal operation on the appropriate semaphores. Thus, the shared data are

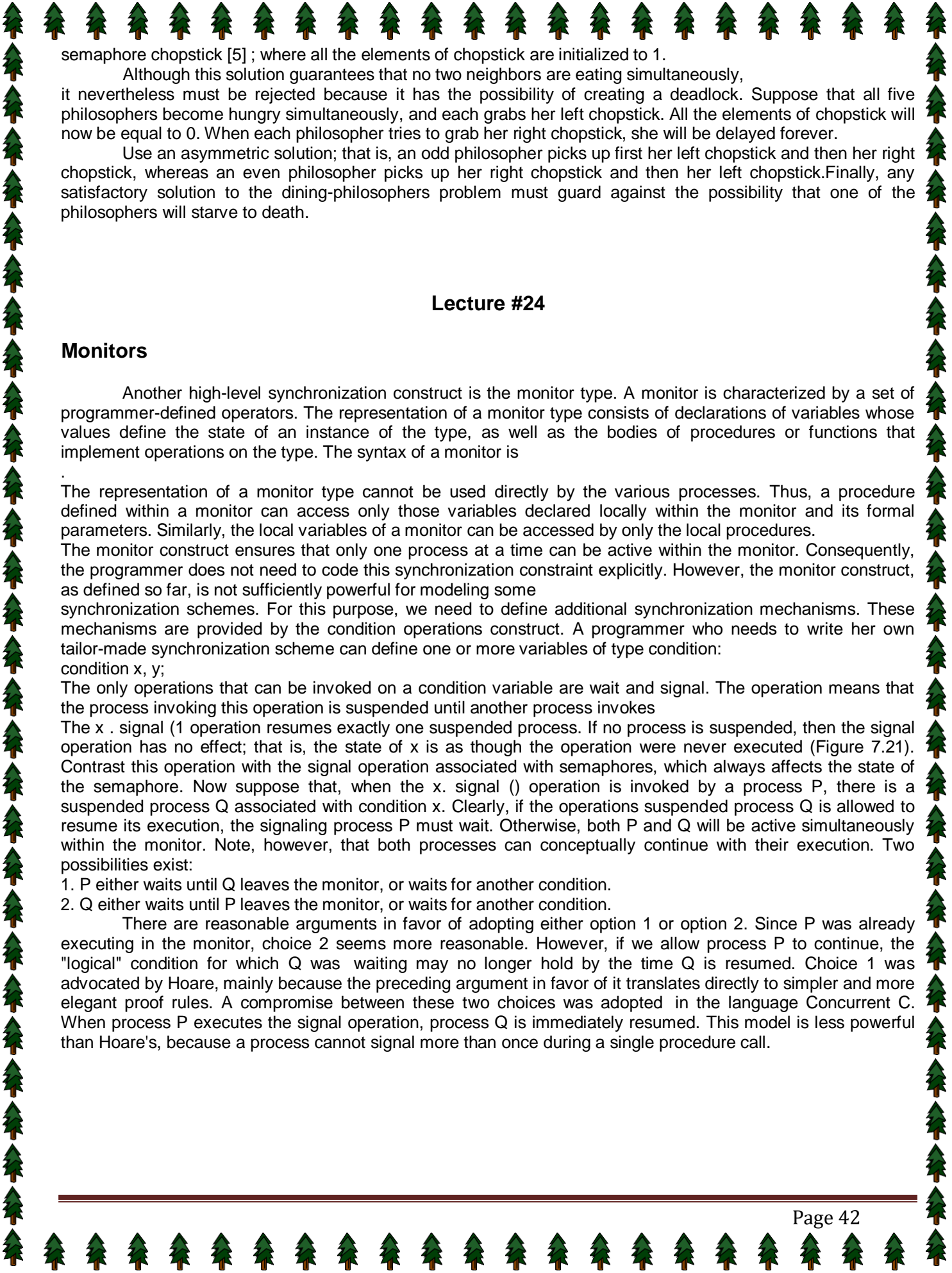

semaphore chopstick [5] ; where all the elements of chopstick are initialized to 1.

Although this solution guarantees that no two neighbors are eating simultaneously, it nevertheless must be rejected because it has the possibility of creating a deadlock. Suppose that all five philosophers become hungry simultaneously, and each grabs her left chopstick. All the elements of chopstick will now be equal to 0. When each philosopher tries to grab her right chopstick, she will be delayed forever.

Use an asymmetric solution; that is, an odd philosopher picks up first her left chopstick and then her right chopstick, whereas an even philosopher picks up her right chopstick and then her left chopstick. Finally, any satisfactory solution to the dining-philosophers problem must guard against the possibility that one of the philosophers will starve to death.

Lecture #24

Monitors

Another high-level synchronization construct is the monitor type. A monitor is characterized by a set of programmer-defined operators. The representation of a monitor type consists of declarations of variables whose values define the state of an instance of the type, as well as the bodies of procedures or functions that implement operations on the type. The syntax of a monitor is

The representation of a monitor type cannot be used directly by the various processes. Thus, a procedure defined within a monitor can access only those variables declared locally within the monitor and its formal parameters. Similarly, the local variables of a monitor can be accessed by only the local procedures.

The monitor construct ensures that only one process at a time can be active within the monitor. Consequently, the programmer does not need to code this synchronization constraint explicitly. However, the monitor construct, as defined so far, is not sufficiently powerful for modeling some synchronization schemes. For this purpose, we need to define additional synchronization mechanisms. These mechanisms are provided by the condition operations construct. A programmer who needs to write her own tailor-made synchronization scheme can define one or more variables of type condition:

condition x, y;

The only operations that can be invoked on a condition variable are wait and signal. The operation means that the process invoking this operation is suspended until another process invokes

The x . signal (1 operation resumes exactly one suspended process. If no process is suspended, then the signal operation has no effect; that is, the state of x is as though the operation were never executed (Figure 7.21). Contrast this operation with the signal operation associated with semaphores, which always affects the state of the semaphore. Now suppose that, when the x . signal () operation is invoked by a process P, there is a suspended process Q associated with condition x. Clearly, if the operations suspended process Q is allowed to resume its execution, the signaling process P must wait. Otherwise, both P and Q will be active simultaneously within the monitor. Note, however, that both processes can conceptually continue with their execution. Two possibilities exist:

1. P either waits until Q leaves the monitor, or waits for another condition.
2. Q either waits until P leaves the monitor, or waits for another condition.

There are reasonable arguments in favor of adopting either option 1 or option 2. Since P was already executing in the monitor, choice 2 seems more reasonable. However, if we allow process P to continue, the "logical" condition for which Q was waiting may no longer hold by the time Q is resumed. Choice 1 was advocated by Hoare, mainly because the preceding argument in favor of it translates directly to simpler and more elegant proof rules. A compromise between these two choices was adopted in the language Concurrent C. When process P executes the signal operation, process Q is immediately resumed. This model is less powerful than Hoare's, because a process cannot signal more than once during a single procedure call.



MODULE-II

Deadlocks

A set of process is in a deadlock state if each process in the set is waiting for an event that can be caused by only another process in the set. In other words, each member of the set of deadlock processes is waiting for a resource that can be released only by a deadlock process. None of the processes can run, none of them can release any resources, and none of them can be awakened.

The resources may be either physical or logical. Examples of physical resources are Printers, Hard Disc Drives, Memory Space, and CPU Cycles. Examples of logical resources are Files, Semaphores, and Monitors.

The simplest example of deadlock is where process 1 has been allocated non-shareable resources A (say a Hard Disc drive) and process 2 has been allocated non-shareable resource B (say a printer). Now, if it turns out that process 1 needs resource B (printer) to proceed and process 2 needs resource A (Hard Disc drive) to proceed and these are the only two processes in the system, each is blocked the other and all useful work in the system stops. This situation is termed deadlock. The system is in deadlock state because each process holds a resource being requested by the other process neither process is willing to release the resource it holds.

Preemptable and Nonpreemptable Resources

Resources come in two flavors: preemptable and nonpreemptable.

- ⇒ A preemptable resource is one that can be taken away from the process with no ill effects. Memory is an example of a preemptable resource.
- ⇒ A nonpreemptable resource is one that cannot be taken away from process (without causing ill effect). For example, CD resources are not preemptable at an arbitrary moment.
- ⇒ Reallocating resources can resolve deadlocks that involve preemptable resources. Deadlocks that involve nonpreemptable resources are difficult to deal with.

Under the normal mode of operation, a process may utilize a resource in only the following sequence:

1. **Request:** If the request cannot be granted immediately, then the requesting process must wait until it can acquire the resource.
2. **Use:** The process can operate on the resource.
3. **Release:** The process releases the resource.

Necessary Conditions for Deadlock

Coffman (1971) identified four conditions that must hold simultaneously for there to be a deadlock.

1. **Mutual Exclusion Condition:** The resources involved are non-shareable.

Explanation: At least one resource must be held in a non-shareable mode, that is, only one process at a time claims exclusive control of the resource. If another process requests that resource, the requesting process must be delayed until the resource has been released.

2. **Hold and Wait Condition:** Requesting process hold already the resources while waiting for requested resources.

Explanation: There must exist a process that is holding a resource already allocated to it while waiting for additional resource that are currently being held by other processes.

4. **No-Preemptive Condition:** Resources already allocated to a process cannot be preempted.

Explanation: Resources cannot be removed from the processes are used to completion or released voluntarily by the process holding it.

4. **Circular Wait Condition:** The processes in the system form a circular list or chain where each process in the list is waiting for a resource held by the next process in the list. There exists a set $\{P_0, P_1, \dots, P_n\}$ of waiting processes such that P_0 is waiting for a resource that is held by P_1 , P_1 is waiting for a resource that is held by P_2 , ..., P_{n-1} is waiting for a resource that is held by P_n , and P_0 is waiting for a resource that is held by P_0 .

Note: It is not possible to have a deadlock involving only one single process. The deadlock involves a circular "hold-and-wait" condition between two or more processes, so "one" process cannot hold a resource, yet be

waiting for another resource that it is holding. In addition, deadlock is not possible between two threads in a process, because it is the process that holds resources, not the thread that is, each thread has access to the resources held by the process.

Resource-Allocation Graph

Deadlocks can be described in terms of a directed graph called a **system resource-allocation graph**.

This graph consists of a set of vertices V and a set of edges E . The set of vertices V is partitioned into two different types of nodes $P = \{P_1, P_2, \dots, P_n\}$, the set consisting of all the active processes in the system, and $R = \{R_1, R_2, \dots, R_m\}$, the set consisting of all resource types in the system.

A directed edge from process P_i to resource type R_j is denoted by $P_i \rightarrow R_j$; it signifies that process P_i requested an instance of resource type R_j and is currently waiting for that resource. A directed edge $P_i \rightarrow R_j$ is called a request edge.

A directed edge from resource type R_j to process P_i is denoted by $R_j \rightarrow P_i$; it signifies that an instance of resource type R_j has been allocated to process P_i . A directed edge $R_j \rightarrow P_i$ is called an assignment edge.

Pictorially, we represent each process P_i as a circle and each resource type R_j as a square. Since resource type R_j may have more than one instance, we represent each such instance as a dot within the square. A request edge points to only the square R_j , whereas an assignment edge must designate one of the dots in the square.



The resource-allocation graph shown below depicts the following situation.

The sets P , R , and E :

$P = \{P_1, P_2, P_3\}$

$R = \{R_1, R_2, R_3, R_4\}$

$E = \{P_1 \rightarrow R_1, P_2 \rightarrow R_3, R_1 \rightarrow P_2, R_2 \rightarrow P_2, R_2 \rightarrow P_1, R_3 \rightarrow P_3\}$

Resource instances:

- One instance of resource type R_1
- Two instances of resource type R_2
- One instance of resource type R_3
- Three instances of resource type R_4

Process states:

- Process P_1 is holding an instance of resource type R_2 , and is waiting for an instance of resource type R_1 .
- Process P_2 is holding an instance of R_1 and R_2 , and is waiting for an instance of resource type R_3 .
- Process P_3 is holding an instance of R_3 .

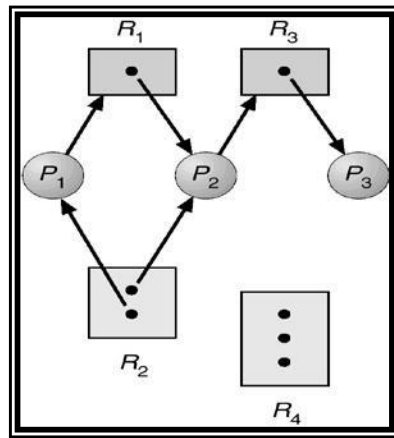

Example of a Resource Allocation Graph

Given the definition of a resource-allocation graph, it can be shown that, if the graph contains no cycles, then no process in the system is deadlocked. If the graph does contain a cycle, then a deadlock may exist.

If each resource type has exactly one instance, then a cycle implies that a deadlock has occurred. If the cycle involves only a set of resource types, each of which has only a single instance, then a deadlock has occurred. Each process involved in the cycle is deadlocked. In this case, a cycle in the graph is both a necessary and a sufficient condition for the existence of deadlock.

If each resource type has several instances, then a cycle does not necessarily imply that a deadlock has occurred. In this case, a cycle in the graph is a necessary but not a sufficient condition for the existence of deadlock.

To illustrate this concept, let us return to the resource-allocation graph depicted in Figure. Suppose that process P_3 requests an instance of resource type R_2 . Since no resource instance is currently available, a request edge $P_3 \rightarrow R_2$ is added to the graph. At this point, two minimal cycles exist in the system:

$P_1 \rightarrow R_1 \rightarrow P_2 \rightarrow R_3 \rightarrow P_3 \rightarrow R_2 \rightarrow P_1$

$P_2 \rightarrow R_3 \rightarrow P_3 \rightarrow R_2 \rightarrow P_2$

Processes P_1 , P_2 , and P_3 are deadlocked. Process P_2 is waiting for the resource R_3 , which is held by process P_3 . Process P_3 , on the other hand, is waiting for either process P_1 or process P_2 to release resource R_2 . In addition, process P_1 is waiting for process P_2 to release resource R_1 .

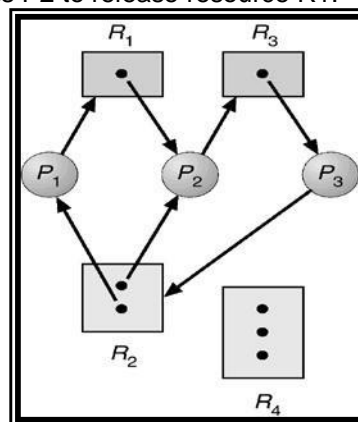

Resource Allocation Graph with a deadlock

Now consider the resource-allocation graph in the following Figure. In this example, we also have a cycle. However, there is no deadlock. Observe that process P_4 may release its instance of resource type R_2 . That resource can then be allocated to P_3 , breaking the cycle.

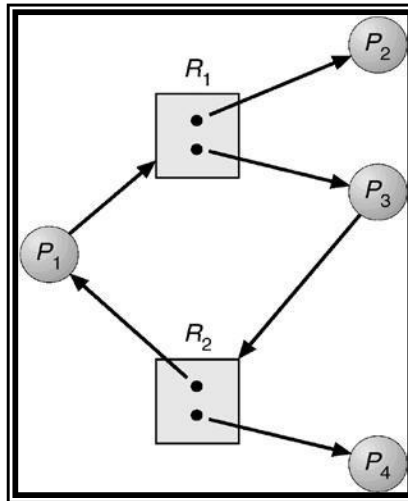

Resource Allocation Graph with a Cycle but No Deadlock

METHODS OF HANDLING DEADLOCK

In general, there are four strategies of dealing with deadlock problem:

1. **Deadlock Prevention:** Prevent deadlock by resource scheduling so as to negate at least one of the four conditions.
2. **Deadlock Avoidance:** Avoid deadlock by careful resource scheduling.
3. **Deadlock Detection and Recovery:** Detect deadlock and when it occurs, take steps to recover.
4. **The Ostrich Approach:** Just ignore the deadlock problem altogether.

DEADLOCK PREVENTION

A deadlock may be prevented by denying any one of the conditions.

- **Elimination of “Mutual Exclusion” Condition:** The mutual exclusion condition must hold for non-sharable resources. That is, several processes cannot simultaneously share a single resource. This condition is difficult to eliminate because some resources, such as the Hard disc drive and printer, are inherently non-shareable. Note that shareable resources like read-only-file do not require mutually exclusive access and thus cannot be involved in deadlock.
- **Elimination of “Hold and Wait” Condition:** There are two possibilities for elimination of the second condition. The first alternative is that a process request be granted all of the resources it needs at once, prior to execution. The second alternative is to disallow a process from requesting resources whenever it has previously allocated resources. This strategy requires that all of the resources a process will need must be requested at once. The system must grant resources on “all or none” basis. If the complete set of resources needed by a process is not currently available, then the process must wait until the complete set is available. While the process waits, however, it may not hold any resources. Thus the “wait for” condition is denied and deadlocks cannot occur. This strategy can lead to serious waste of resources.
- **Elimination of “No-preemption” Condition:** The non-preemption condition can be alleviated by forcing a process waiting for a resource that cannot immediately be allocated to relinquish all of its currently held resources, so that other processes may use them to finish. This strategy requires that when a process that is holding some resources is denied a request for additional resources. The process must release its held resources and, if necessary, request them again together with additional resources. Implementation of this strategy denies the “no-preemptive” condition effectively.
- **Elimination of “Circular Wait” Condition:** The last condition, the circular wait, can be denied by imposing a total ordering on all of the resource types and then forcing, all processes to request the resources in order (increasing or decreasing). This strategy impose a total ordering of all resources types, and to require that each process requests resources in a numerical order (increasing or decreasing) of enumeration. With this rule, the resource allocation graph can never have a cycle.

For example, provide a global numbering of all the resources, as shown

- 1 ≡ Card reader
- 2 ≡ Printer
- 3 ≡ Optical driver
- 4 ≡ HDD
- 5 ≡ Card punch

Now the rule is this: processes can request resources whenever they want to, but all requests must be made in numerical order. A process may request first printer and then a HDD (order: 2, 4), but it may not request first a optical driver and then a printer (order: 3, 2). The problem with this strategy is that it may be impossible to find an ordering that satisfies everyone.

DEADLOCK AVOIDANCE

This approach to the deadlock problem anticipates deadlock before it actually occurs. This approach employs an algorithm to assess the possibility that deadlock could occur and acting accordingly. If the necessary conditions for a deadlock are in place, it is still possible to avoid deadlock by being careful when resources are allocated. It employs the most famous deadlock avoidance algorithm that is the Banker's algorithm.

A deadlock-avoidance algorithm dynamically examines the resource-allocation state to ensure that a circular wait condition can never exist. The resource-allocation *state* is defined by the number of available and allocated resources, and the maximum demands of the processes.

Safe and Unsafe States

A system is said to be in a **Safe State**, if there is a safe execution sequence. An execution sequence is an ordering for process execution such that each process runs until it terminates or blocked and all request for resources are immediately granted if the resource is available.

A system is said to be in an **Unsafe State**, if there is no safe execution sequence. An unsafe state may not be deadlocked, but there is at least one sequence of requests from processes that would make the system deadlocked.

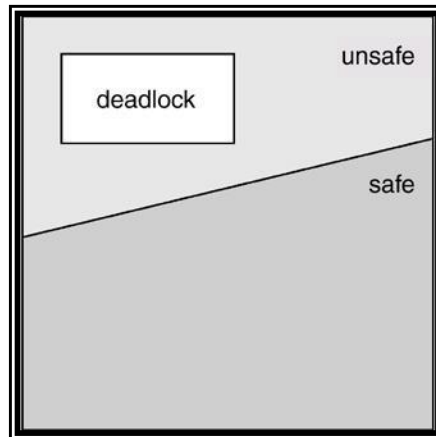

(Relation between Safe, Unsafe and Deadlocked States)

Resource-Allocation Graph Algorithm

The deadlock avoidance algorithm uses a variant of the resource-allocation graph to avoid deadlocked state. It introduces a new type of edge, called a **claim edge**. A claim edge $P_i \rightarrow R_j$ indicates that process P_i may request resource R_j at some time in the future. This edge resembles a request edge in direction, but is represented by a dashed line. When process P_i requests resource R_j , the claim edge $P_i \rightarrow R_j$ is converted to a request edge. Similarly, when a resource R_j is released by P_i , the assignment edge $R_j \rightarrow P_i$ is reconverted to a claim edge $P_i \rightarrow R_j$.

Suppose that process P_i requests resource R_j . The request can be granted only if converting the request edge $P_i \rightarrow R_j$ to an assignment edge $R_j \rightarrow P_i$ that does not result in the formation of a cycle in the resource-allocation graph. An algorithm for detecting a cycle in this graph is called cycle detection algorithm.

If no cycle exists, then the allocation of the resource will leave the system in a safe state. If a cycle is found, then the allocation will put the system in an unsafe state. Therefore, process P_i will have to wait for its requests to be satisfied.

Banker's algorithm

The **Banker's algorithm** is a resource allocation & deadlock avoidance algorithm developed by Edsger Dijkstra that test for safety by simulating the allocation of pre-determined maximum possible amounts of all resources. Then it makes a "safe-state" check to test for possible deadlock conditions for all other pending activities, before deciding whether allocation should be allowed to continue.

The Banker's algorithm is run by the operating system whenever a process requests resources. The algorithm prevents deadlock by denying or postponing the request if it determines that accepting the request could put the system in an unsafe state (one where deadlock could occur).

For the Banker's algorithm to work, it needs to know three things:

- How much of each resource could possibly request by each process.
- How much of each resource is currently holding by each process.
- How much of each resource the system currently has available.

Resources may be allocated to a process only if it satisfies the following conditions:

1. request \leq max, else set error as process has crossed maximum claim made by it.
2. request \leq available, else process waits until resources are available.

Several data structures must be maintained to implement the banker's algorithm. These data structures encode the state of the resource-allocation system. Let n be the number of processes in the system and m be the number of resource types. We need the following data structures:

Available: A vector of length m indicates the number of available resources of each type. If $Available[j] = k$, there are k instances of resource type R_j available.

Max: An $n \times m$ matrix defines the maximum demand of each process. If $Max[i,j] = k$, then process P_i may request at most k instances of resource type R_j .

Allocation: An $n \times m$ matrix defines the number of resources of each type currently allocated to each process. If $Allocation[i,j] = k$, then process P_i is currently allocated k instances of resource type R_j .

Need: An $n \times m$ matrix indicates the remaining resource need of each process. If $Need[i,j] = k$, then process P_i may need k more instances of resource type R_j to complete its task. Note that $Need[i,j] = Max[i,j] - Allocation[i,j]$.

These data structures vary over time in both size and value. The vector $Allocation_i$ specifies the resources currently allocated to process P_i ; the vector $Need_i$ specifies the additional resources that process P_i may still request to complete its task.

Safety Algorithm

The algorithm for finding out whether or not a system is in a safe state can be described as follows:

1. Let $Work$ and $Finish$ be vectors of length m and n , respectively. Initialize
 $Work := Available$ and $Finish[i] := false$ for $i = 1, 2, \dots, n$.
2. Find an i such that both a. $Finish[i] = false$
b. $Need_i \leq Work$.
If no such i exists, go to step 4.
3. $Work := Work + Allocation_i$
 $Finish[i] := true$
go to step 2.
4. If $Finish[i] = true$ for all i , then the system is in a safe state.

This algorithm may require an order of $m \times n^2$ operations to decide whether a state is safe.

Resource-Request Algorithm

Let $Request_i$ be the request vector for process P_i . If $Request_i[j] = k$, then process P_i wants k instances of resource type R_j . When a request for resources is made by process P_i , the following actions are taken:

1. If $Request_i \leq Need_i$, go to step 2. Otherwise, raise an error condition, since the process has exceeded its maximum claim.
2. If $Request_i \leq Available$, go to step 3. Otherwise, P_i must wait, since the resources are not available.
3. Have the system pretend to have allocated the requested resources to process P_i by modifying the state as follows:
 - Available := Available - Request;
 - Allocation_{*i*} := Allocation_{*i*} + Request;
 - Need_{*i*} := Need_{*i*} - Request;

If the resulting resource-allocation state is safe, the transaction is completed and process P_i is allocated its resources. However, if the new state is unsafe, then P_i must wait for $Request_i$ and the old resource-allocation state is restored.

Consider a system with five processes P0 through P4 and three resource types A,B,C. Resource type A has 10 instances, resource type B has 5 instances, and resource type C has 7 instances. Suppose that, at time T0, the following snapshot of the system has been taken:

	Allocation	Max	Available
	-----	-----	-----
	A B C	A B C	A B C
P0	0 1 0	7 5 3	3 3 2
P1	2 0 0	3 2 2	
P2	3 0 2	9 0 2	
P3	2 1 1	2 2 2	
P4	0 0 2	4 3 3	

The content of the matrix Need is defined to be Max - Allocation and is

	Need

	A B C
P0	7 4 3
P1	1 2 2
P2	6 0 0
P3	0 1 1
P4	4 3 1

We claim that the system is currently in a safe state. Indeed, the sequence $\langle P1, P3, P4, P2, P0 \rangle$ satisfies the safety criteria. Suppose now that process P1 requests one additional instance of resource type A and two instances of resource type C, so $Request1 = (1,0,2)$. To decide whether this request can be immediately granted, we first check that $Request1 \leq Available$ (that is, $(1,0,2) \leq (3,3,2)$), which is true. We then pretend that this request has been fulfilled, and we arrive at the following new state:

	Allocation	Need	Available
	-----	-----	-----
	A B C	A B C	A B C
P0	0 1 0	7 4 3	2 3 0
P1	3 0 2	0 2 0	
P2	3 0 2	6 0 0	
P3	2 1 1	0 1 1	
P4	0 0 2	4 3 1	

We must determine whether this new system state is safe. To do so, we execute our safety algorithm and find that the sequence $\langle P_1, P_3, P_4, P_0, P_2 \rangle$ satisfies our safety requirement. Hence, we can immediately grant the request of process P_1 .

However, that when the system is in this state, a request for (3,3,0) by P_4 cannot be granted, since the resources are not available. A request for (0,2,0) by P_0 cannot be granted, even though the resources are available, since the resulting state is unsafe.

DEADLOCK DETECTION

If a system does not employ either a deadlock-prevention or a deadlock avoidance algorithm, then a deadlock situation may occur. In this environment, the system must provide:

- An algorithm that examines the state of the system to determine whether a deadlock has occurred.
- An algorithm to recover from the deadlock.

According to number of instances in each resource type, the Deadlock Detection algorithm can be classified into two categories as follows:

1. Single Instance of Each Resource Type: If all resources have only a single instance, then it can define a deadlock detection algorithm that uses a variant of the resource-allocation graph (is called a *wait-for* graph). A wait-for graph can be drawn by removing the nodes of type resource and collapsing the appropriate edges from the resource-allocation graph.

An edge from P_i to P_j in a wait-for graph implies that process P_i is waiting for process P_j to release a resource that P_i needs. An edge $P_i \rightarrow P_j$ exists in a wait-for graph if and only if the corresponding resource allocation graph contains two edges $P_i \rightarrow R_q$ and $R_q \rightarrow P_j$ for some resource R_q . For Example:

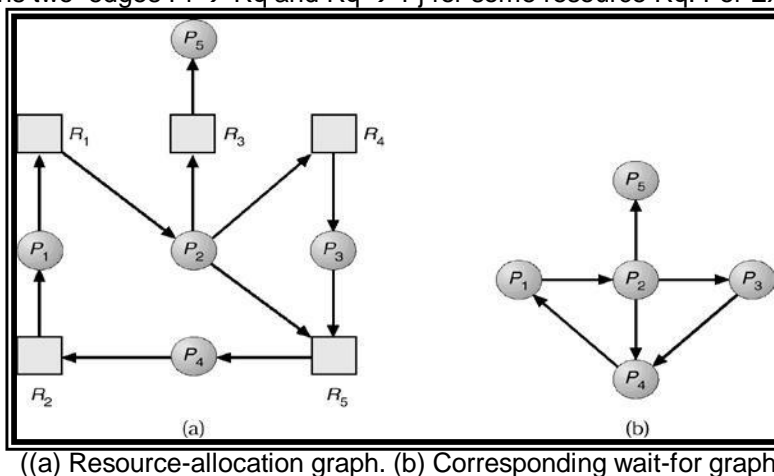

A deadlock exists in the system if and only if the wait-for graph contains a cycle. To detect deadlocks, the system needs to maintain the wait-for graph and periodically to invoke an algorithm that searches for a cycle in the graph. An algorithm to detect a cycle in a graph requires an order of n^2 operations, where n is the number of vertices in the graph.

2. Several Instances of a Resource Type: The following deadlock-detection algorithm is applicable to several instances of a resource type. The algorithm employs several time-varying data structures:

Available: A vector of length m indicates the number of available resources of each type.

Allocation: An $n \times m$ matrix defines the number of resources of each type currently allocated to each process.

Request: An $n \times m$ matrix indicates the current request of each process. If $\text{Request}[i,j] = k$, then process P_i is requesting k more instances of resource type R_j .

The detection algorithm is described as follows:

1. Let *Work* and *Finish* be vectors of length m and n , respectively.
Initialize, $\text{Work} := \text{Available}$. For $i = 1, 2, \dots, n$,
if $\text{Allocation}_i \neq 0$, then $\text{Finish}[i] := \text{false}$; otherwise, $\text{Finish}[i] := \text{true}$.
2. Find an index i such that both
 - a. $\text{Finish}[i] = \text{false}$.

b. $Request_i \leq Work$.

If no such i exists, go to step 4.

3. $Work := Work + Allocation_i$

$Finish[i] := true$

go to step 2.

4. If $Finish[i] = false$, for some i , $1 \leq i \leq n$, then the system is in a deadlock state.
if $Finish[i] = false$, then process P_i is deadlocked.

This algorithm requires an order of $m \times n^2$ operations to detect whether the system is in a deadlocked state.

RECOVERY FROM DEADLOCK

When a detection algorithm determines that a deadlock exists, then the system or operator is responsible for handling deadlock problem. There are two options for breaking a deadlock.

1. Process Termination
2. Resource preemption
- 3.

Process Termination

There are two method to eliminate deadlocks by terminating a process as follows:

1. **Abort all deadlocked processes:** This method will break the deadlock cycle clearly by terminating all process. This method is cost effective. And it removes the partial computations completed by the processes.
2. **Abort one process at a time until the deadlock cycle is eliminated:** This method terminates one process at a time, and invokes a deadlock-detection algorithm to determine whether any processes are still deadlocked.

Resource Preemption

In resource preemption, the operator or system preempts some resources from processes and give these resources to other processes until the deadlock cycle is broken.

If preemption is required to deal with deadlocks, then three issues need to be addressed:

1. **Selecting a victim:** The system or operator selects which resources and which processes are to be preempted based on cost factor.
2. **Rollback:** The system or operator must roll back the process to some safe state and restart it from that state.
3. **Starvation:** The system or operator should ensure that resources will not always be preempted from the same process?

MEMORY MANAGEMENT

In a uni-programming system, main memory is divided into two parts: one part for the operating system (resident monitor, kernel) and one part for the user program currently being executed.

In a multiprogramming system, the “user” part of memory must be further subdivided to accommodate multiple processes. The task of subdivision is carried out dynamically by the operating system and is known as **memory management**.

Binding of Instructions and Data to Memory

Address binding of instructions and data to memory addresses can happen at three different stages.

1. **Compile time:** The compile time is the time taken to compile the program or source code. During compilation, if memory location known a priori, then it generates absolute codes.

2. **Load time:** It is the time taken to link all related program file and load into the main memory. It must generate relocatable code if memory location is not known at compile time.
3. **Execution time:** It is the time taken to execute the program in main memory by processor. Binding delayed until run time if the process can be moved during its execution from one memory segment to another. Need hardware support for address maps (e.g., base and limit registers).

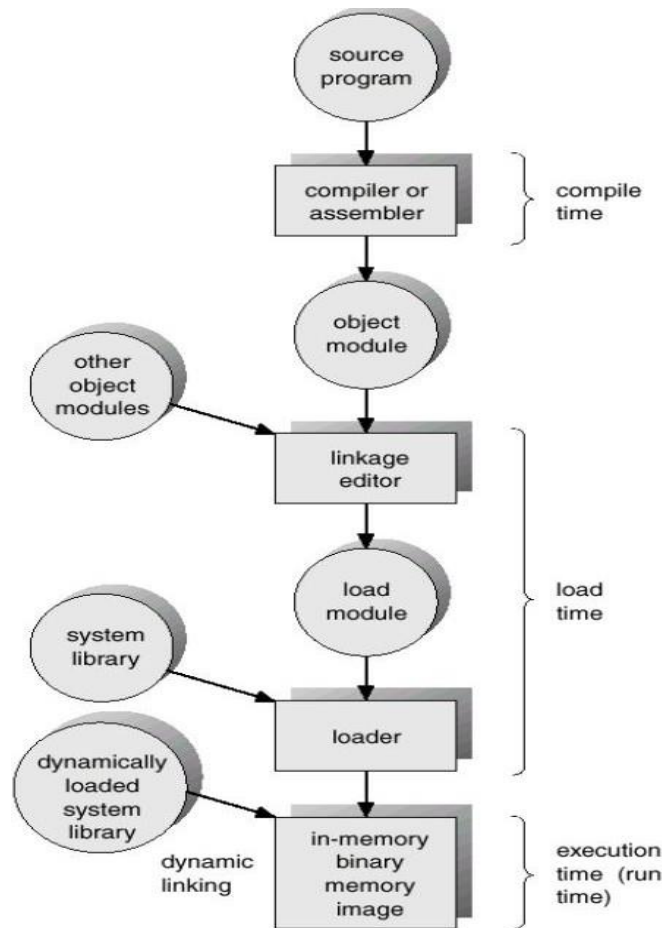

(Multistep processing of a user program.)

Logical- Versus Physical-Address Space

- ⇒ An address generated by the CPU is commonly referred to as a **logical address** or a **virtual address** whereas an address seen by the main memory unit is commonly referred to as a **physical address**.
- ⇒ The set of all logical addresses generated by a program is a **logical-address space** whereas the set of all physical addresses corresponding to these logical addresses is a **physical-address space**.
- ⇒ Logical and physical addresses are the same in compile-time and load-time address-binding schemes; logical (virtual) and physical addresses differ in execution-time address-binding scheme.
- ⇒ The Memory Management Unit is a hardware device that maps virtual to physical address. In MMU scheme, the value in the relocation register is added to every address generated by a user process at the time it is sent to memory as follows:

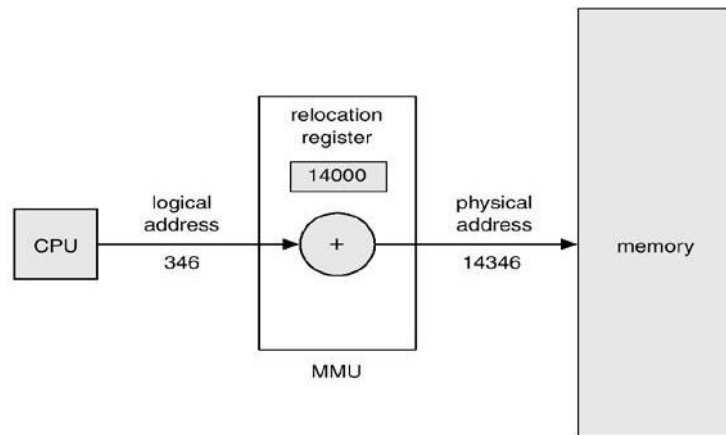

(Dynamic relocation using a relocation register)

Dynamic Loading

- ⇒ It loads the program and data dynamically into physical memory to obtain better memory-space utilization.
- ⇒ With dynamic loading, a routine is not loaded until it is called.
- ⇒ The advantage of dynamic loading is that an unused routine is never loaded.
- ⇒ This method is useful when large amounts of code are needed to handle infrequently occurring cases, such as error routines.
- ⇒ Dynamic loading does not require special support from the operating system.

Dynamic Linking

- ⇒ Linking postponed until execution time.
- ⇒ Small piece of code (stub) used to locate the appropriate memory-resident library routine.
- ⇒ Stub replaces itself with the address of the routine and executes the routine.
- ⇒ Operating system needed to check if routine is in processes memory address.
- ⇒ Dynamic linking is particularly useful for libraries.

Overlays

- ⇒ Keep in memory only those instructions and data that are needed at any given time.
- ⇒ Needed when process is larger than amount of memory allocated to it.
- ⇒ Implemented by user, no special support needed from operating system, programming design of overlay structure is complex.

Swapping

- ⇒ A process can be swapped temporarily out of memory to a backing store (large disc), and then brought back into memory for continued execution.
- ⇒ **Roll out, roll in:** A variant of this swapping policy is used for priority-based scheduling algorithms. If a higher-priority process arrives and wants service, the memory manager can swap out the lower-priority process so that it can load and execute the higher-priority process. When the higher-priority process finishes, the lower-priority process can be swapped back in and continued. This variant of swapping is called **roll out, roll in**.
- ⇒ Major part of swap time is transfer time; total transfer time is directly proportional to the amount of memory swapped.
- ⇒ Modified versions of swapping are found on many systems (UNIX, Linux, and Windows).

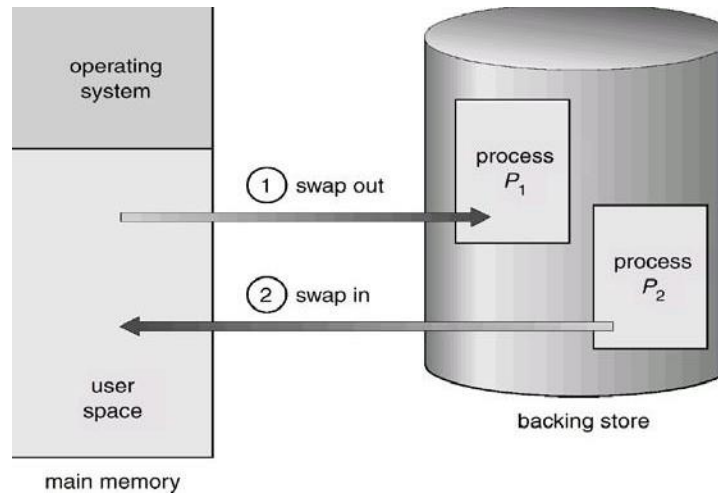

(Schematic View of Swapping)

MEMORY ALLOCATION

The main memory must accommodate both the operating system and the various user processes. We need to allocate different parts of the main memory in the most efficient way possible.

The main memory is usually divided into two partitions: one for the resident operating system, and one for the user processes. We may place the operating system in either low memory or high memory. The major factor affecting this decision is the location of the interrupt vector. Since the interrupt vector is often in low memory, programmers usually place the operating system in low memory as well.

There are following two ways to allocate memory for user processes:

1. Contiguous memory allocation
2. Non contiguous memory allocation

1. Contiguous Memory Allocation

Here, all the processes are stored in contiguous memory locations. To load multiple processes into memory, the Operating System must divide memory into multiple partitions for those processes.

Hardware Support: The relocation-register scheme used to protect user processes from each other, and from changing operating system code and data. Relocation register contains value of smallest physical address of a partition and limit register contains range of that partition. Each logical address must be less than the limit register.

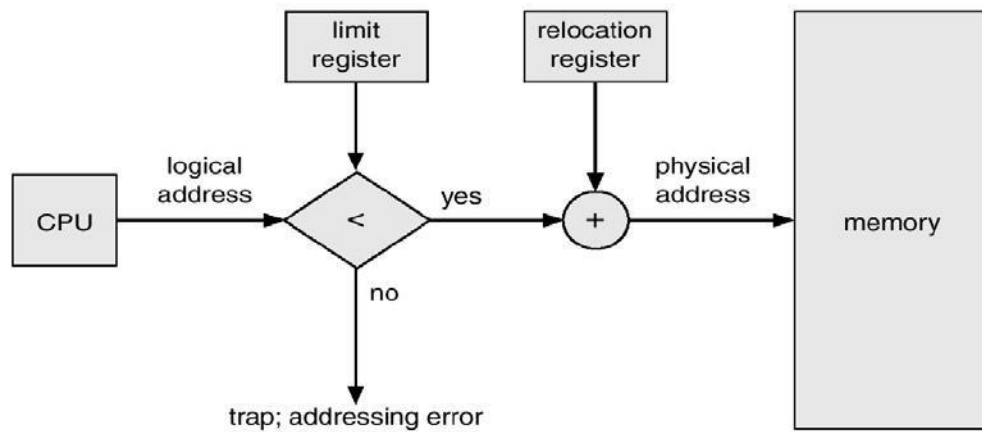

(Hardware support for relocation and limit registers)

According to size of partitions, the multiple partition schemes are divided into two types:

- i. Multiple fixed partition/ multiprogramming with fixed task(MFT)
- ii. Multiple variable partition/ multiprogramming with variable task(MVT)

i. Multiple fixed partitions: Main memory is divided into a number of static partitions at system generation time. In this case, any process whose size is less than or equal to the partition size can be loaded into any available partition. If all partitions are full and no process is in the Ready or Running state, the operating system can swap a process out of any of the partitions and load in another process, so that there is some work for the processor.

Advantages: Simple to implement and little operating system overhead.

Disadvantage: * Inefficient use of memory due to internal fragmentation.
* Maximum number of active processes is fixed.

ii. Multiple variable partitions: With this partitioning, the partitions are of variable length and number. When a process is brought into main memory, it is allocated exactly as much memory as it requires and no more.

Advantages: No internal fragmentation and more efficient use of main memory.

Disadvantages: Inefficient use of processor due to the need for compaction to counter external fragmentation.

Partition Selection policy:

When the multiple memory holes (partitions) are large enough to contain a process, the operating system must use an algorithm to select in which hole the process will be loaded. The partition selection algorithm are as follows:

- ⇒ **First-fit:** The OS looks at all sections of free memory. The process is allocated to the first hole found that is big enough size than the size of process.
- ⇒ **Next Fit:** The next fit search starts at the last hole allocated and The process is allocated to the next hole found that is big enough size than the size of process.
- ⇒ **Best-fit:** The Best Fit searches the entire list of holes to find the smallest hole that is big enough size than the size of process.
- ⇒ **Worst-fit:** The Worst Fit searches the entire list of holes to find the largest hole that is big enough size than the size of process.

Fragmentation: The wasting of memory space is called fragmentation. There are two types of fragmentation as follows:

1. **External Fragmentation:** The total memory space exists to satisfy a request, but it is not contiguous. This wasted space not allocated to any partition is called external fragmentation. The external fragmentation can be reduce by compaction. The goal is to shuffle the memory contents to place all free memory together in one large block. Compaction is possible only if relocation is dynamic, and is done at execution time.
2. **Internal Fragmentation:** The allocated memory may be slightly larger than requested memory. The wasted space within a partition is called internal fragmentation. One method to reduce internal fragmentation is to use partitions of different size.

2. Noncontiguous memory allocation

In noncontiguous memory allocation, it is allowed to store the processes in non contiguous memory locations. There are different techniques used to load processes into memory, as follows:

1. Paging
2. Segmentation
3. Virtual memory paging(Demand paging) etc.

PAGING

Main memory is divided into a number of equal-size blocks, are called **frames**. Each process is divided into a number of equal-size block of the same length as frames, are called **Pages**. A process is loaded by loading all of its pages into available frames (may not be contiguous).

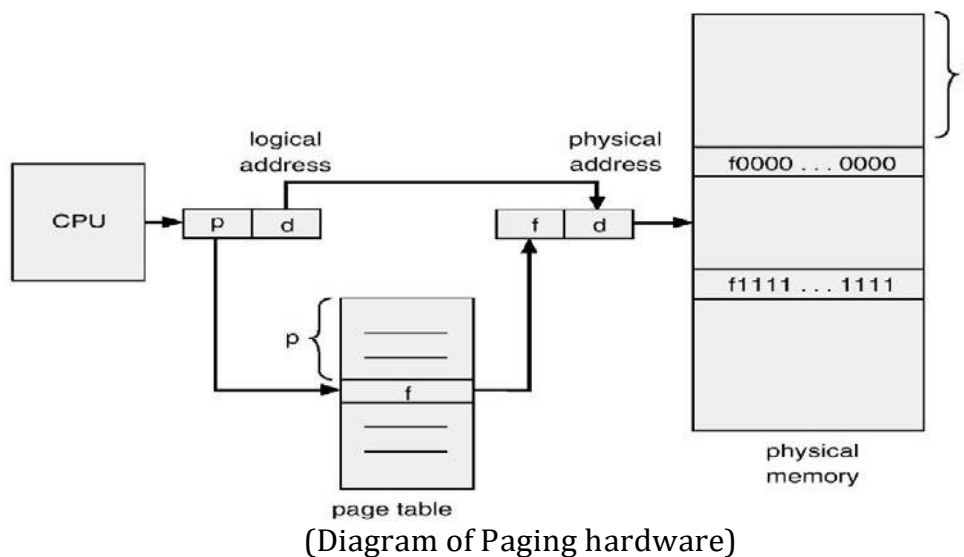

Process of Translation from logical to physical addresses

- ⇒ Every address generated by the CPU is divided into two parts: a page number (**p**) and a page offset (**d**). The page number is used as an index into a page table.
- ⇒ The page table contains the base address of each page in physical memory. This base address is combined with the page offset to define the physical memory address that is sent to the memory unit.
- ⇒ If the size of logical-address space is 2^m and a page size is 2^n addressing units (bytes or words), then the high-order $(m - n)$ bits of a logical address designate the page number and the n low-order bits designate the page offset. Thus, the logical address is as follows:

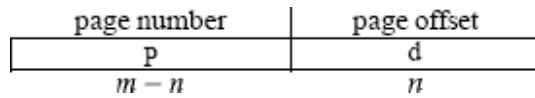

Where p is an index into the page table and d is the displacement within the page.

Example:

Consider a page size of 4 bytes and a physical memory of 32 bytes (8 pages), we show how the user's view of memory can be mapped into physical memory. Logical address 0 is page 0, offset 0. Indexing into the page table, we find that page 0 is in frame 5. Thus, logical address 0 maps to physical address 20 (= (5 x 4) + 0). Logical address 3 (page 0, offset 3) maps to physical address 23 (= (5 x 4) + 3). Logical address 4 is page 1, offset 0; according to the page table, page 1 is mapped to frame 6. Thus, logical address 4 maps to physical address 24 (= (6 x 4) + 0). Logical address 13 maps to physical address 9 (= (2 x 4) + 1).

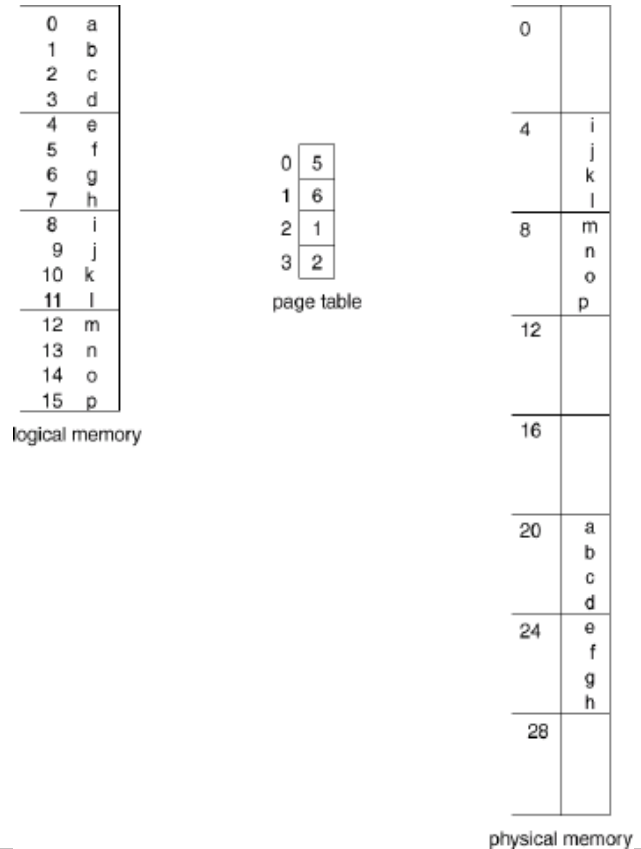

Hardware Support for Paging:

Each operating system has its own methods for storing page tables. Most operating systems allocate a page table for each process. A pointer to the page table is stored with the other register values (like the instruction counter) in the process control block. When the dispatcher is told to start a process, it must reload the user registers and define the correct hardware page table values from the stored user page table.

Implementation of Page Table

- ⇒ Generally, Page table is kept in main memory. The Page Table Base Register (PTBR) points to the page table. And Page-table length register (PRLR) indicates size of the page table.
- ⇒ In this scheme every data/instruction access requires two memory accesses. One for the page table and one for the data/instruction.
- ⇒ The two memory access problem can be solved by the use of a special fast-lookup hardware cache called **associative memory** or **translation look-aside buffers (TLBs)**.

Paging Hardware With TLB

The TLB is an associative and high-speed memory. Each entry in the TLB consists of two parts: a key (or tag) and a value. The TLB is used with page tables in the following way.

- ⇒ The TLB contains only a few of the page-table entries. When a logical address is generated by the CPU, its page number is presented to the TLB.
- ⇒ If the page number is found (known as a **TLB Hit**), its frame number is immediately available and is used to access memory. It takes only one memory access.
- ⇒ If the page number is not in the TLB (known as a **TLB miss**), a memory reference to the page table must be made. When the frame number is obtained, we can use it to access memory. It takes two memory accesses.
- ⇒ In addition, it stores the page number and frame number to the TLB, so that they will be found quickly on the next reference.
- ⇒ If the TLB is already full of entries, the operating system must select one for replacement by using replacement algorithm.

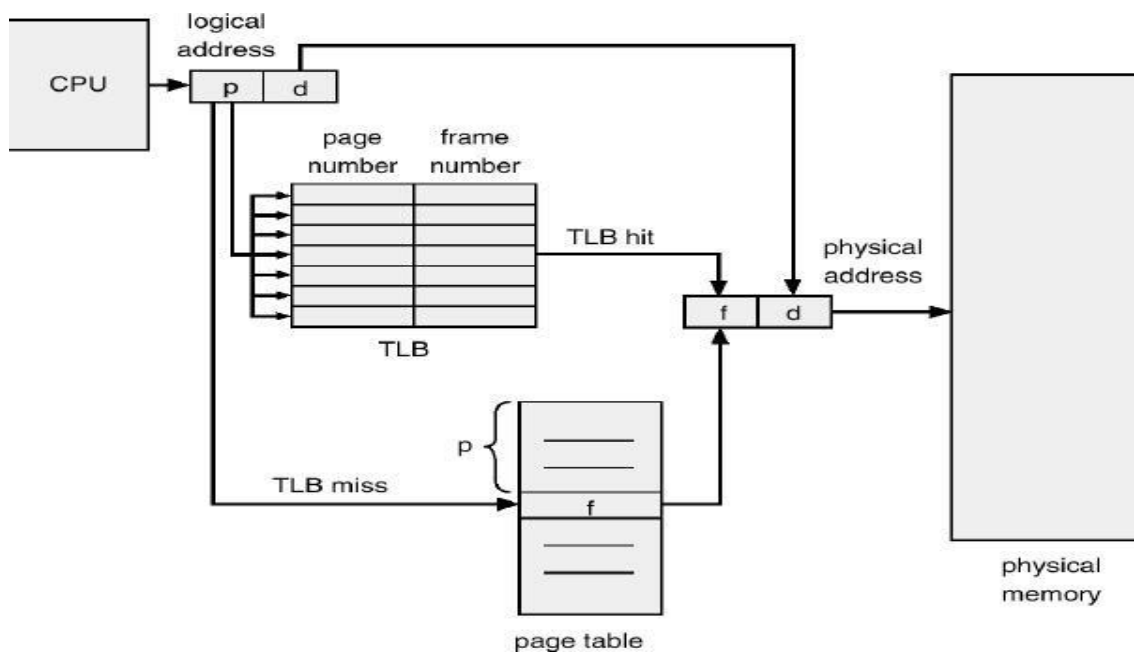

(Paging hardware with TLB)

The percentage of times that a particular page number is found in the TLB is called the **hit ratio**. The effective access time (EAT) is obtained as follows:

$$EAT = HR \times (TLBAT + MAT) + MR \times (TLBAT + 2 \times MAT)$$

Where HR: Hit Ratio, TLBAT: TLB access time, MAT: Memory access time, MR: Miss Ratio.

Memory protection in Paged Environment:

- ⇒ Memory protection in a paged environment is accomplished by protection bits that are associated with each frame. These bits are kept in the page table.
- ⇒ One bit can define a page to be read-write or read-only. This protection bit can be checked to verify that no writes are being made to a read-only page. An attempt to write to a read-only page causes a hardware trap to the operating system (or memory-protection violation).

- ⇒ One more bit is attached to each entry in the page table: a **valid-invalid** bit. When this bit is set to "valid," this value indicates that the associated page is in the process' logical-address space, and is a legal (or valid) page. If the bit is set to "invalid," this value indicates that the page is not in the process' logical-address space.
- ⇒ Illegal addresses are trapped by using the valid-invalid bit. The operating system sets this bit for each page to allow or disallow accesses to that page.

00000	page 0
	page 1
	page 2
	page 3
	page 4
10,468	page 5
12,287	

	frame number	valid-invalid bit
0	2	v
1	3	v
2	4	v
3	7	v
4	8	v
5	9	v
6	0	i
7	0	i

page table

0	
1	
2	page 0
3	page 1
4	page 2
5	
6	
7	page 3
8	page 4
9	page 5
	⋮
	page n

(Valid (v) or invalid (i) bit in a page table)

Structure of the Page Table

There are different structures of page table described as follows:

1. Hierarchical Page table: When the number of pages is very high, then the page table takes large amount of memory space. In such cases, we use multilevel paging scheme for reducing size of page table. A simple technique is a two-level page table. Since the page table is paged, the page number is further divided into parts: page number and page offset. Thus, a logical address is as follows:

page number	page offset
p_1	p_2
	d

Where p_1 is an index into the outer page table, and p_2 is the displacement within the page of the outer page table.

Two-Level Page-Table Scheme:

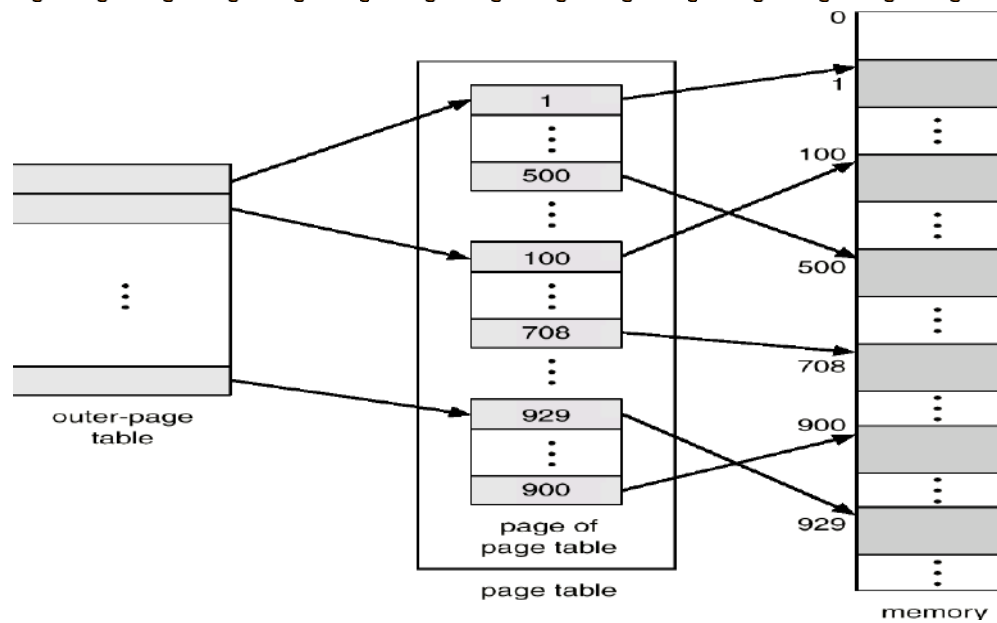

Address translation scheme for a two-level paging architecture:

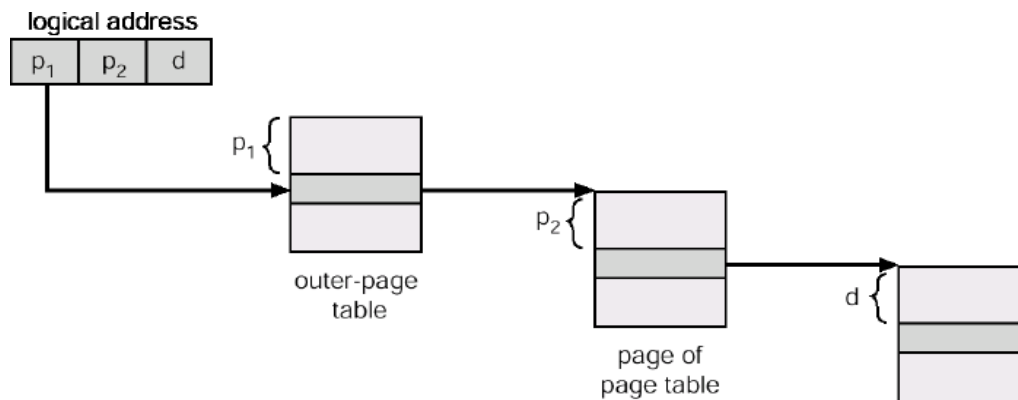

2. Hashed Page Tables: This scheme is applicable for address space larger than 32bits. In this scheme, the virtual page number is hashed into a page table. This page table contains a chain of elements hashing to the same location. Virtual page numbers are compared in this chain searching for a match. If a match is found, the corresponding physical frame is extracted.

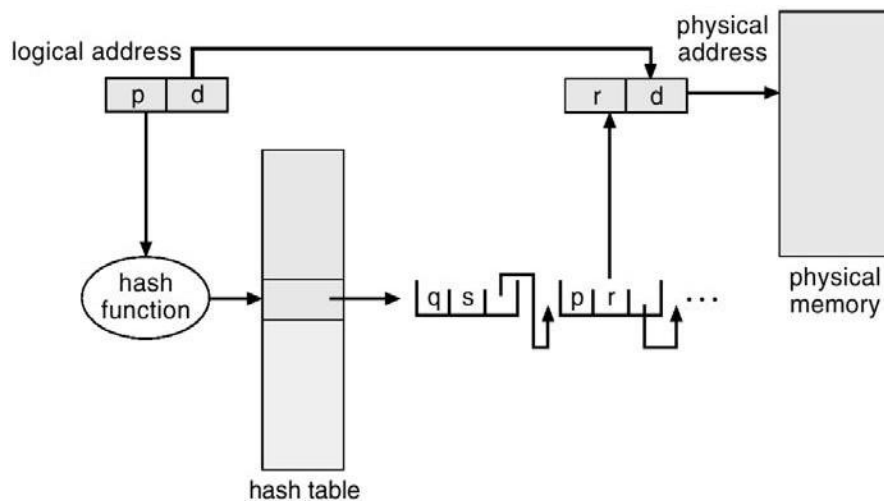

3. Inverted Page Table:

- ⇒ One entry for each real page of memory.
- ⇒ Entry consists of the virtual address of the page stored in that real memory location, with information about the process that owns that page.
- ⇒ Decreases memory needed to store each page table, but increases time needed to search the table when a page reference occurs.

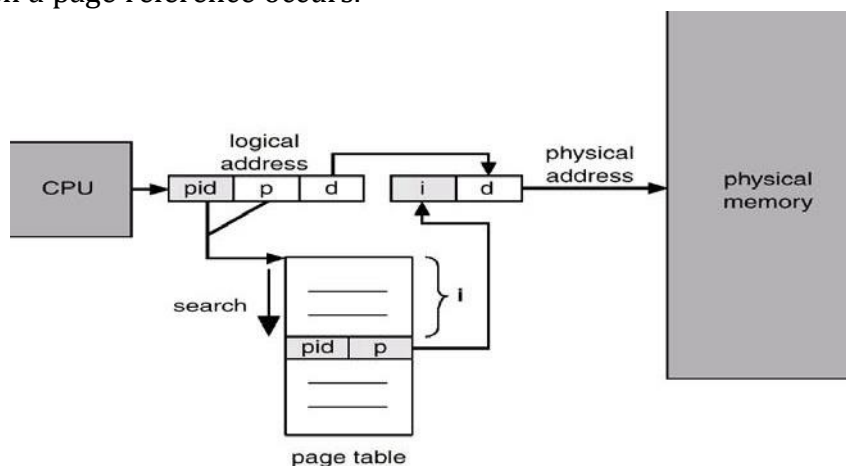

Shared Pages

Shared code

- ⇒ One copy of read-only (reentrant) code shared among processes (i.e., text editors, compilers, window systems).
- ⇒ Shared code must appear in same location in the logical address space of all processes.

Private code and data

- ⇒ Each process keeps a separate copy of the code and data.
- ⇒ The pages for the private code and data can appear anywhere in the logical address space.

SEGMENTATION

Segmentation is a memory-management scheme that supports user view of memory. A program is a collection of segments. A segment is a logical unit such as: main program,

procedure, function, method, object, local variables, global variables, common block, stack, symbol table, arrays etc.

A logical-address space is a collection of segments. Each segment has a name and a length. The user specifies each address by two quantities: a segment name/number and an offset.

Hence, Logical address consists of a two tuple: <segment-number, offset>

Segment table maps two-dimensional physical addresses and each entry in table has:

base – contains the starting physical address where the segments reside in memory.

limit – specifies the length of the segment.

Segment-table base register (STBR) points to the segment table's location in memory.

Segment-table length register (STLR) indicates number of segments used by a program.

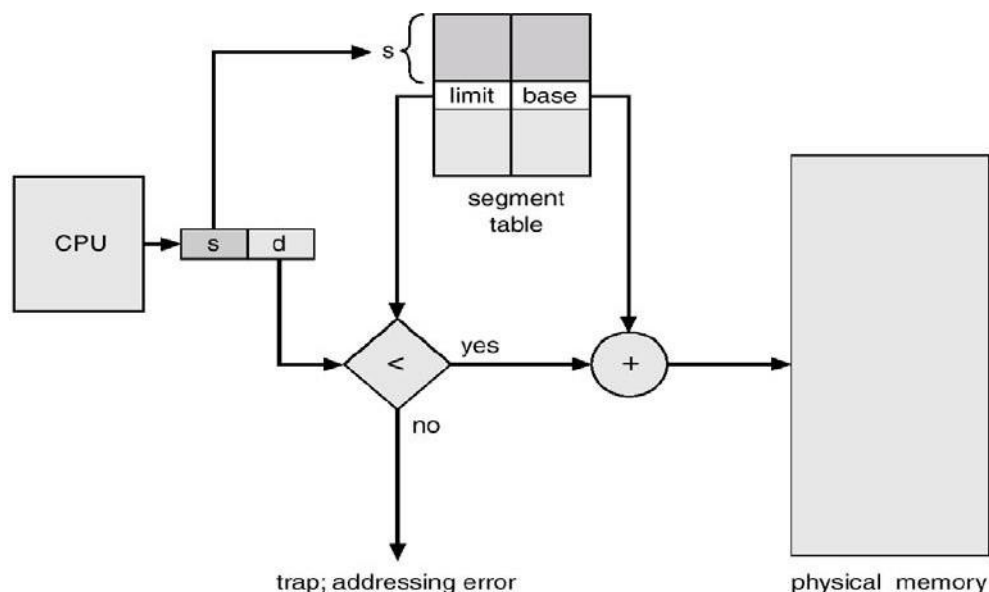

(Diagram of Segmentation Hardware)

The segment number is used as an index into the segment table. The offset d of the logical address must be between 0 and the segment limit. If it is not, we trap to the operating system that logical addressing attempt beyond end of segment. If this offset is legal, it is added to the segment base to produce the address in physical memory of the desired byte.

Consider we have five segments numbered from 0 through 4. The segments are stored in physical memory as shown in figure. The segment table has a separate entry for each segment, giving start address in physical memory (or base) and the length of that segment (or limit). For example, segment 2 is 400 bytes long and begins at location 4300. Thus, a reference to byte 53 of segment 2 is mapped onto location $4300 + 53 = 4353$.

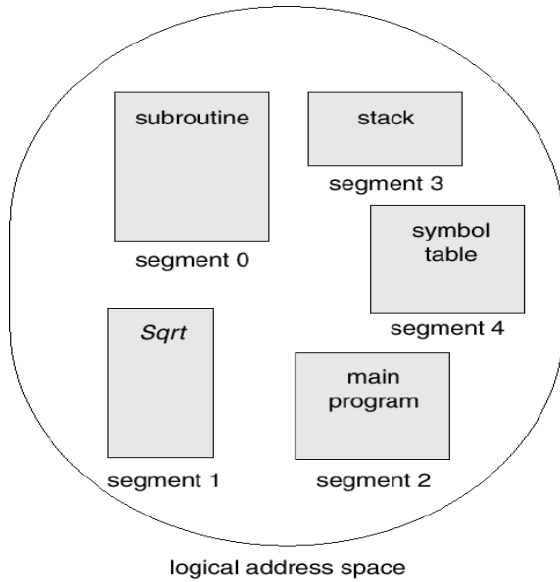

	limit	base
0	1000	1400
1	400	6300
2	400	4300
3	1100	3200
4	1000	4700

segment table

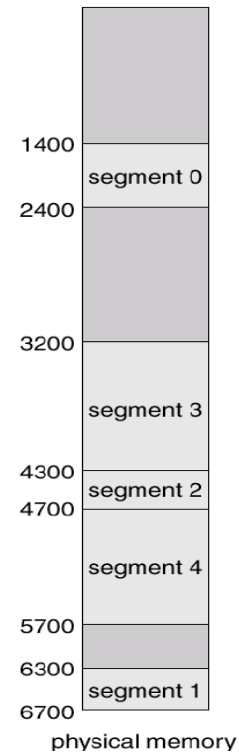

(Example of segmentation)

VIRTUAL MEMORY

Virtual memory is a technique that allows the execution of processes that may not be completely in memory. Only part of the program needs to be in memory for execution. It means that Logical address space can be much larger than physical address space. Virtual memory allows processes to easily share files and address spaces, and it provides an efficient mechanism for process creation.

Virtual memory is the separation of user logical memory from physical memory. This separation allows an extremely large virtual memory to be provided for programmers when only a smaller physical memory is available. Virtual memory makes the task of programming much easier, because the programmer no longer needs to worry about the amount of physical memory available.

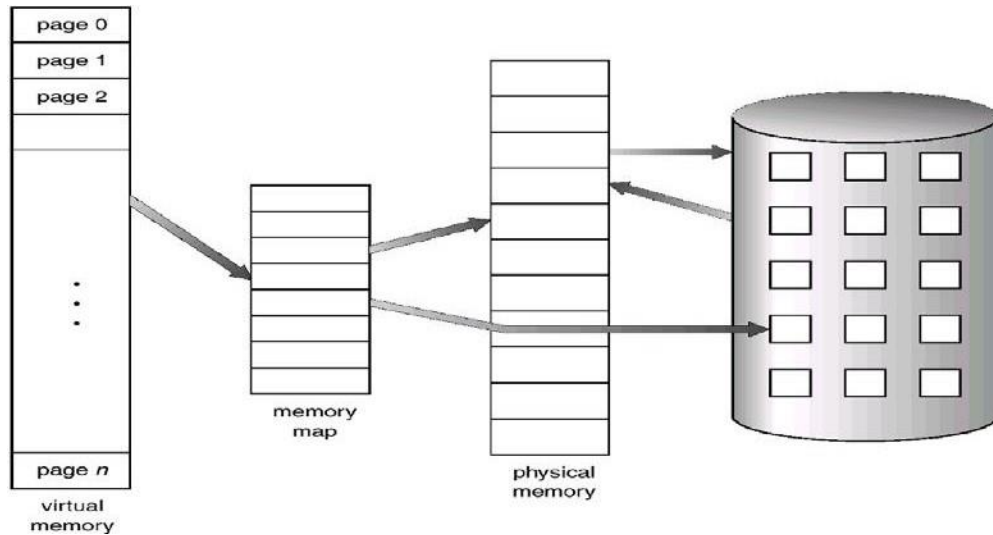

(Diagram showing virtual memory that is larger than physical memory)

Virtual memory can be implemented via:

- Demand paging
- Demand segmentation

DEMAND PAGING

A demand-paging system is similar to a paging system with swapping. Generally, Processes reside on secondary memory (which is usually a disk). When we want to execute a process, we swap it into memory. Rather than swapping the entire process into memory, it swaps the required page. This can be done by a **lazy swapper**.

A lazy swapper never swaps a page into memory unless that page will be needed. A swapper manipulates entire processes, whereas a **pager** is concerned with the individual pages of a process.

Page transfer Method: When a process is to be swapped in, the pager guesses which pages will be used before the process is swapped out again. Instead of swapping in a whole process, the pager brings only those necessary pages into memory. Thus, it avoids reading into memory pages that will not be used anyway, decreasing the swap time and the amount of physical memory needed.

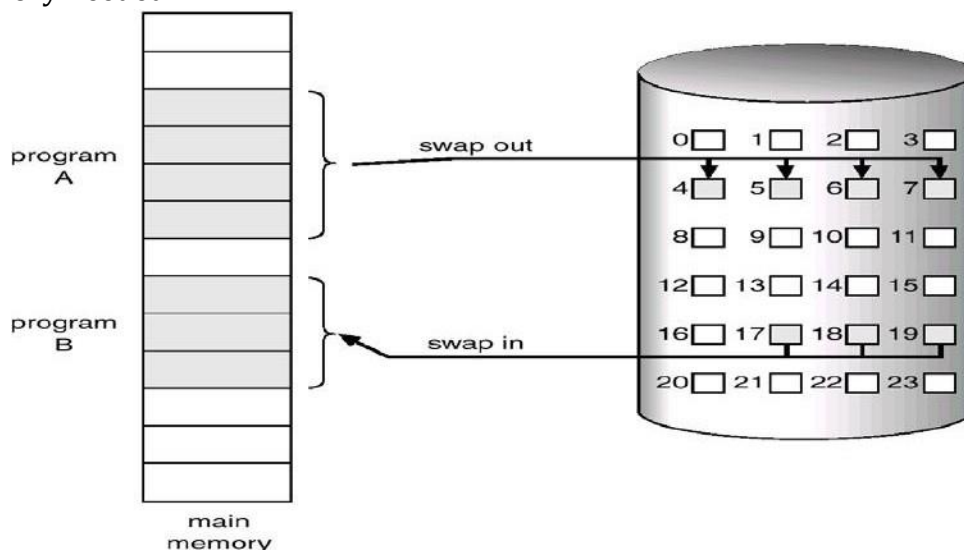

(Transfer of a paged memory to contiguous disk space)

Page Table:

- The valid-invalid bit scheme of Page table can be used for indicating which pages are currently in memory.
- When this bit is set to "valid", this value indicates that the associated page is both legal and in memory. If the bit is set to "invalid", this value indicates that the page either is not valid or is valid but is currently on the disk.
- The page-table entry for a page that is brought into memory is set as usual, but the page-table entry for a page that is not currently in memory is simply marked invalid, or contains the address of the page on disk.

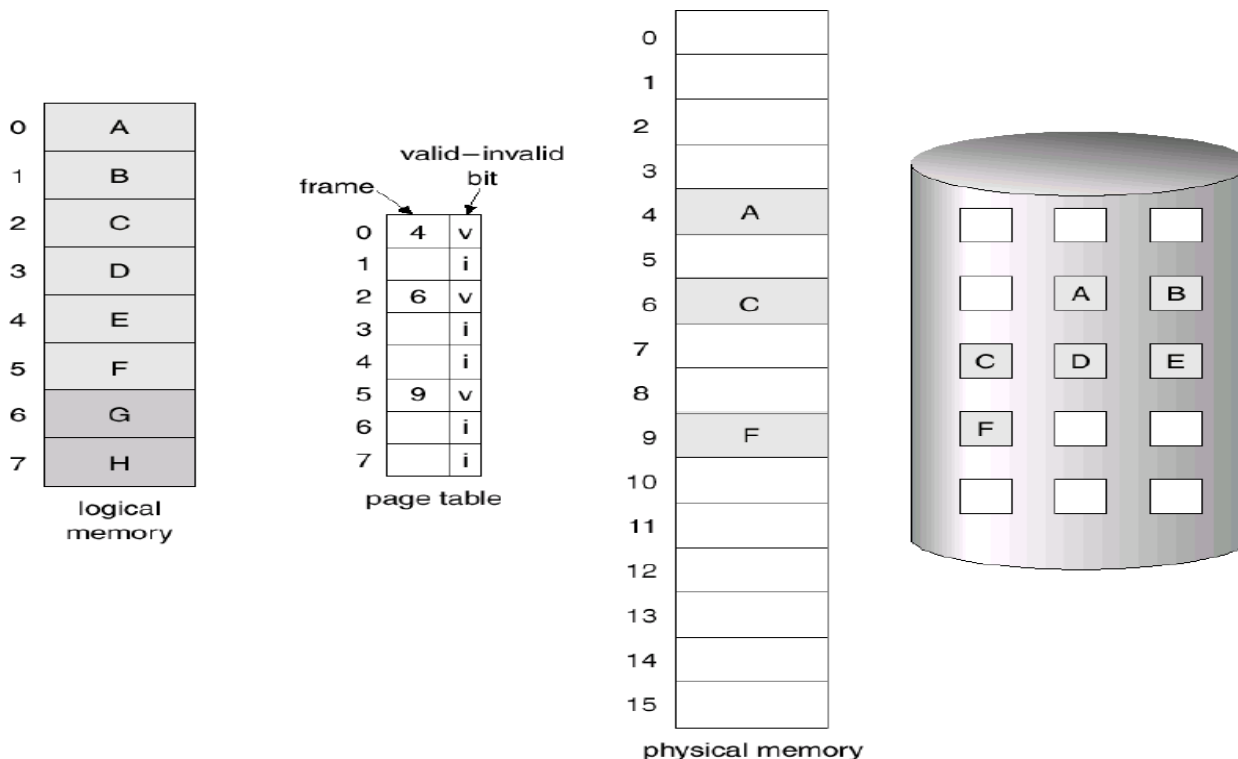

(Page table when some pages are not in main memory)

When a page references an invalid page, then it is called **Page Fault**. It means that page is not in main memory. The procedure for handling page fault is as follows:

1. We check an internal table for this process, to determine whether the reference was a valid or invalid memory access.
2. If the reference was invalid, we terminate the process. If it was valid, but we have not yet brought in that page in to memory.
3. We find a free frame (by taking one from the free-frame list).
4. We schedule a disk operation to read the desired page into the newly allocated frame.
5. When the disk read is complete, we modify the internal table kept with the process and the page table to indicate that the page is now in memory.
6. We restart the instruction that was interrupted by the illegal address trap. The process can now access the page as though it had always been in memory.

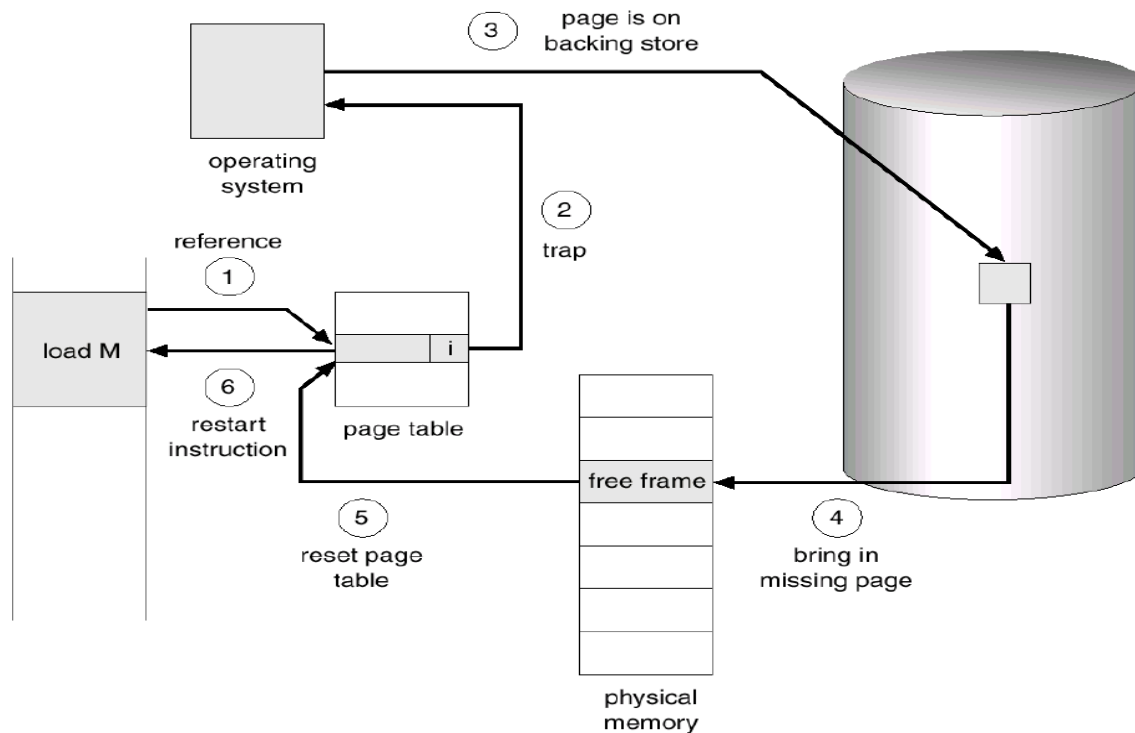

(Diagram of Steps in handling a page fault)

Note: The pages are copied into memory, only when they are required. This mechanism is called **Pure Demand Paging**.

Performance of Demand Paging

Let p be the probability of a page fault ($0 \leq p \leq 1$). Then the **effective access time** is

$$\text{Effective access time} = (1 - p) \times \text{memory access time} + p \times \text{page fault time}$$

In any case, we are faced with three major components of the page-fault service time:

1. Service the page-fault interrupt.
2. Read in the page.
3. Restart the process.

PAGE REPLACEMENT

The **page replacement** is a mechanism that loads a page from disc to memory when a page of memory needs to be allocated. Page replacement can be described as follows:

1. Find the location of the desired page on the disk.
2. Find a free frame:
 - a. If there is a free frame, use it.
 - b. If there is no free frame, use a page-replacement algorithm to select a victim frame.
 - c. Write the victim page to the disk; change the page and frame tables accordingly.
3. Read the desired page into the (newly) free frame; change the page and frame tables.
4. Restart the user process.

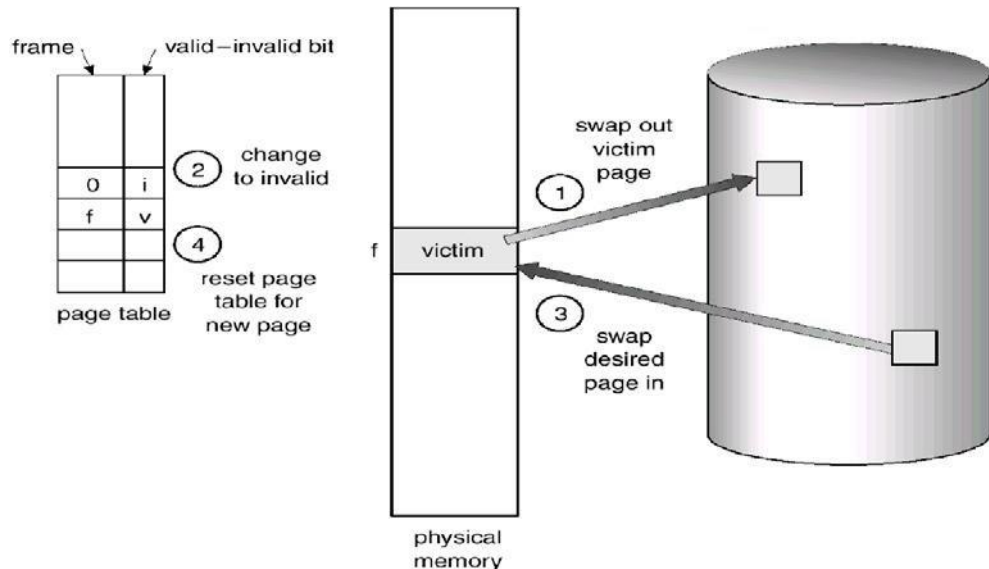

(Diagram of Page replacement)

Page Replacement Algorithms: The page replacement algorithms decide which memory pages to page out (swap out, write to disk) when a page of memory needs to be allocated. We evaluate an algorithm by running it on a particular string of memory references and computing the number of page faults. The string of memory references is called a **reference string**.

The different page replacement algorithms are described as follows:

1. **First-In-First-Out (FIFO) Algorithm:**

A FIFO replacement algorithm associates with each page the time when that page was brought into memory. When a page must be replaced, the oldest page is chosen to swap out. We can create a FIFO queue to hold all pages in memory. We replace the page at the head of the queue. When a page is brought into memory, we insert it at the tail of the queue.

Example:

reference string

7 0 1 2 0 3 0 4 2 3 0 3 2 1 2 0 1 7 0 1

7	7	7	2	2	2	4	4	4	0	0	0	7	7	7
	0	0	0	3	3	3	2	2	2	1	1	1	0	0
		1	1	1	0	0	0	3	3	3	2	2	2	1

page frames

(FIFO page-replacement algorithm)

Note: For some page-replacement algorithms, the page fault rate may *increase* as the number of allocated frames increases. This most unexpected result is known as **Belady's anomaly**.

2. **Optimal Page Replacement algorithm:**

One result of the discovery of Belady's anomaly was the search for an **optimal page replacement algorithm**. An optimal page-replacement algorithm has the lowest page-fault rate of all algorithms, and will never suffer from Belady's anomaly. Such an algorithm does exist, and has been called OPT or MIN.

It is simply "Replace the page that will not be used for the longest period of time". Use of this page-replacement algorithm guarantees the lowest possible pagefault rate for a fixed number of frames.

Example:

reference string

7 0 1 2 0 3 0 4 2 3 0 3 2 1 2 0 1 7 0 1



page frames

(Optimal page-replacement algorithm)

3. LRU Page Replacement algorithm

If we use the recent past as an approximation of the near future, then we will replace the page that has not been used for the longest period of time. This approach is the **least-recently-used (LRU)** algorithm.

LRU replacement associates with each page the time of that page's last use. When a page must be replaced, LRU chooses that page that has not been used for the longest period of time.

Example:

reference string

7 0 1 2 0 3 0 4 2 3 0 3 2 1 2 0 1 7 0 1

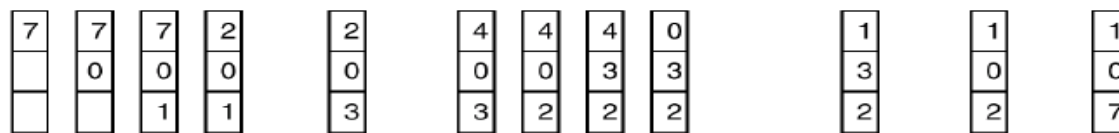

page frames

(LRU page-replacement algorithm)

The major problem is **how** to implement LRU replacement. An LRU page-replacement algorithm may require substantial hardware assistance. The problem is to determine an order for the frames defined by the time of last use. Two implementations are feasible:

Counters: We associate with each page-table entry a time-of-use field, and add to the CPU a logical clock or counter. The clock is incremented for every memory reference. Whenever a reference to a page is made, the contents of the clock register are copied to the time-of-use field in the page-table entry for that page. We replace the page with the smallest time value. This scheme requires a search of the page table to find the LRU page, and a write to memory (to the time-of-use field in the page table) for each memory access. The times must also be maintained when page tables are changed (due to CPU scheduling).

Stack: Another approach to implementing LRU replacement is to keep a stack of page numbers. Whenever a page is referenced, it is removed from the stack and put on the top. In this way, the top of the stack is always the most recently used page and the bottom is the LRU page. Because entries must be removed from the middle of the stack, it is best implemented by a doubly linked list, with a head and tail pointer. Each update is a little more expensive, but there is no search for a replacement; the tail pointer points to the bottom of the stack,

which is the LRU page. This approach is particularly appropriate for software or microcode implementations of LRU replacement. Example:

reference string
4 7 0 7 1 0 1 2 1 2 7 1 2

2
1
0
7
4

7
2
1
0
4

a b

stack before a

stack after b

(Use of a stack to record the most recent page references)

4. LRU Approximation Page Replacement algorithm

In this algorithm, Reference bits are associated with each entry in the page table. Initially, all bits are cleared (to 0) by the operating system. As a user process executes, the bit associated with each page referenced is set (to 1) by the hardware. After some time, we can determine which pages have been used and which have not been used by examining the reference bits.

This algorithm can be classified into different categories as follows:

i. Additional-Reference-Bits Algorithm: It can keep an 8-bit(1 byte) for each page in a page table in memory. At regular intervals, a timer interrupt transfers control to the operating system. The operating system shifts the reference bit for each page into the high-order bit of its 8-bit, shifting the other bits right over 1 bit position, discarding the low-order bit. These 8 bits shift registers contain the history of page use for the last eight time periods.

If we interpret these 8-bits as unsigned integers, the page with the lowest number is the LRU page, and it can be replaced.

ii. Second-Chance Algorithm: The basic algorithm of second-chance replacement is a FIFO replacement algorithm. When a page has been selected, we inspect its reference bit. If the value is 0, we proceed to replace this page. If the reference bit is set to 1, we give that page a second chance and move on to select the next FIFO page. When a page gets a second chance, its reference bit is cleared and its arrival time is reset to the current time. Thus, a page that is given a second chance will not be replaced until all other pages are replaced.

5. Counting-Based Page Replacement

We could keep a counter of the number of references that have been made to each page, and develop the following two schemes.

i. LFU page replacement algorithm: The **least frequently used (LFU) page-replacement algorithm** requires that the page with the smallest count be replaced. The reason for this selection is that an actively used page should have a large reference count.

ii. MFU page-replacement algorithm: The **most frequently used (MFU) page replacement algorithm** is based on the argument that the page with the largest count be replaced.

ALLOCATION OF FRAMES

When a page fault occurs, there is a free frame available to store new page into a frame. While the page swap is taking place, a replacement can be selected, which is written to the disk as the user process continues to execute. The operating system allocate all its buffer and table space from the free-frame list for new page.

Two major allocation Algorithm/schemes.

1. **equal allocation**
2. **proportional allocation**

1. Equal allocation: The easiest way to split m frames among n processes is to give everyone an equal share, m/n frames. This scheme is called **equal allocation**.

2. proportional allocation: Here, it allocates available memory to each process according to its size. Let the size of the virtual memory for process p_i be S_i , and define $S = \sum S_i$. Then, if the total number of available frames is m , we allocate a_i frames to process p_i , where a_i is approximately $a_i = S_i / S \times m$.

Global Versus Local Allocation

We can classify page-replacement algorithms into two broad categories: **global replacement** and **local replacement**.

Global replacement allows a process to select a replacement frame from the set of all frames, even if that frame is currently allocated to some other process; one process can take a frame from another.

Local replacement requires that each process select from only its own set of allocated frames.

THRASHING

The system spends most of its time shuttling pages between main memory and secondary memory due to frequent page faults. This behavior is known as thrashing.

A process is thrashing if it is spending more time paging than executing. This leads to: low CPU utilization and the operating system thinks that it needs to increase the degree of multiprogramming.

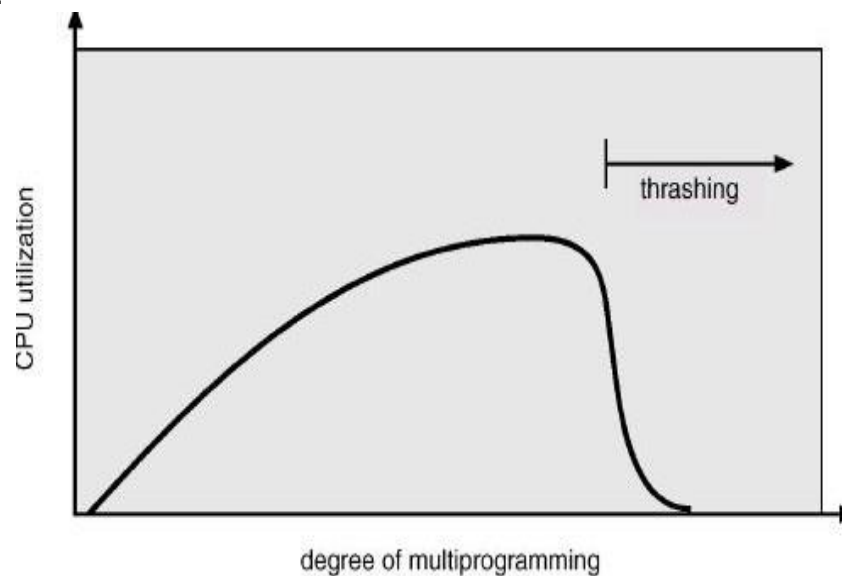

(Thrashing)

A decorative border of green trees surrounds the page. The trees are arranged in a rectangular frame, with a horizontal row at the top, a horizontal row at the bottom, and vertical columns on the left and right sides. The trees are stylized with green foliage and brown trunks.

MODULE-III



FILE SYSTEM INTERFACE

The file system provides the mechanism for on-line storage of and access to both data and programs of the operating system and all the users of the computer system. The file system consists of two distinct parts: a collection of files, each storing related data, and a directory structure, which organizes and provides information about all the files in the system.

FILE CONCEPT

A file is a collection of related information that is recorded on secondary storage. From a user's perspective, a file is the smallest allotment of logical secondary storage and data can not be written to secondary storage unless they are within a file.

Four terms are in common use when discussing files: Field, Record, File and Database

- ⇒ A **field** is the basic element of data. An individual field contains a single value, such as an employee's last name, a date, or the value of a sensor reading. It is characterized by its length and data type.
- ⇒ A **record** is a collection of related fields that can be treated as a unit by some application program. For example, an employee record would contain such fields as name, social security number, job classification, date of hire, and so on.
- ⇒ A **file** is a collection of similar records. The file is treated as a single entity by users and applications and may be referenced by name.
- ⇒ A **database** is a collection of related data. A database may contain all of the information related to an organization or project, such as a business or a scientific study. The database itself consists of one or more types of files.

File Attributes:

A file has the following attributes:

- ⇒ **Name:** The symbolic file name is the only information kept in human readable form.
- ⇒ **Identifier:** This unique tag, usually a number, identifies the file within the file system; it is the non-human-readable name for the file.
- ⇒ **Type:** This information is needed for those systems that support different types.
- ⇒ **Location:** This information is a pointer to a device and to the location of the file on that device.
- ⇒ **Size:** The current size of the file (in bytes, words, or blocks), and possibly the maximum allowed size are included in this attribute.
- ⇒ **Protection:** Access-control information determines who can do reading, writing, executing, and so on.
- ⇒ **Time, date, and user identification:** This information may be kept for creation, modification and last use. These data can be useful for protection, security, and usage monitoring.

File Operations:

The operating system can provide system calls to create, write, read, reposition, delete, and truncate files. The file operations are described as followed:

- ➔ **Creating a file:** Two steps are necessary to create a file. First, space in the file system must be found for the file. Second, an entry for the new file must be made in the directory. The directory entry records the name of the file and the location in the file system, and possibly other information.

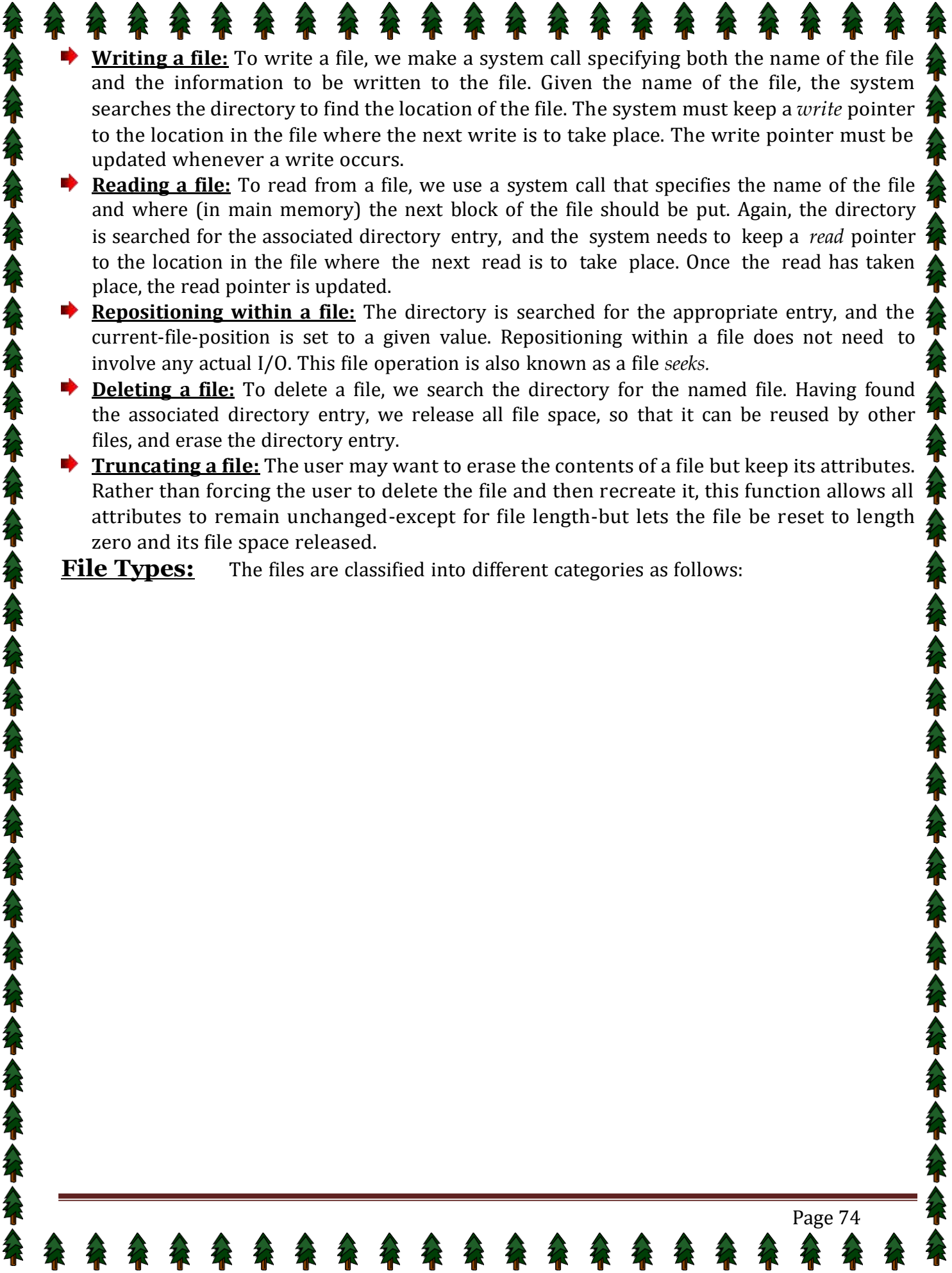
- 
- ➔ **Writing a file:** To write a file, we make a system call specifying both the name of the file and the information to be written to the file. Given the name of the file, the system searches the directory to find the location of the file. The system must keep a *write* pointer to the location in the file where the next write is to take place. The write pointer must be updated whenever a write occurs.
 - ➔ **Reading a file:** To read from a file, we use a system call that specifies the name of the file and where (in main memory) the next block of the file should be put. Again, the directory is searched for the associated directory entry, and the system needs to keep a *read* pointer to the location in the file where the next read is to take place. Once the read has taken place, the read pointer is updated.
 - ➔ **Repositioning within a file:** The directory is searched for the appropriate entry, and the current-file-position is set to a given value. Repositioning within a file does not need to involve any actual I/O. This file operation is also known as a file *seeks*.
 - ➔ **Deleting a file:** To delete a file, we search the directory for the named file. Having found the associated directory entry, we release all file space, so that it can be reused by other files, and erase the directory entry.
 - ➔ **Truncating a file:** The user may want to erase the contents of a file but keep its attributes. Rather than forcing the user to delete the file and then recreate it, this function allows all attributes to remain unchanged-except for file length-but lets the file be reset to length zero and its file space released.

File Types: The files are classified into different categories as follows:

file type	usual extension	function
executable	exe, com, bin or none	read to run machine-language program
object	obj, o	compiled, machine language, not linked
source code	c, cc, java, pas, asm, a	source code in various languages
batch	bat, sh	commands to the command interpreter
text	txt, doc	textual data, documents
word processor	wp, tex, rrf, doc	various word-processor formats
library	lib, a, so, dll, mpeg, mov, rm	libraries of routines for programmers
print or view	arc, zip, tar	ASCII or binary file in a format for printing or viewing
archive	arc, zip, tar	related files grouped into one file, sometimes compressed, for archiving or storage
multimedia	mpeg, mov, rm	binary file containing audio or A/V information

The name is split into two parts—a name and an extension. The system uses the extension to indicate the type of the file and the type of operations that can be done on that file.

ACCESS METHODS

When a file is used, this information must be accessed and read into computer memory. The information in the file can be accessed in several ways. There are two major access methods as follows:

Sequential Access: Information in the file is processed in order, one record after the other. A read operation reads the next portion of the file and automatically advances a file pointer, which tracks the I/O location. Similarly, a write appends to the end of the file and advances to the end of the newly written material (the new end of file). Sequential access is based on a tape model of a file, and works as well on sequential-access devices as it does on random-access ones.

Direct Access: A file is made up of fixed length **logical records** that allow programs to read and write records rapidly in no particular order. The direct-access method is based on a disk model of a file, since disks allow random access to any file block. For direct access, the file is viewed as a numbered sequence of blocks or records. A direct-access file allows arbitrary blocks to be read or written. There are no restrictions on the order of reading or writing for a direct-access file. For the direct-access method, the file operations must be

modified to include the block number as a parameter. Thus, we have *read n*, where *n* is the block number, rather than *read next*, and *write n* rather than *write next*.

DIRECTORY STRUCTURE

A directory is an object that contains the names of file system objects. File system allows the users to organize files and other file system objects through the use of directories. The structure created by placement of names in directories can take a number of forms: Single-level tree, Two-level tree, multi-level tree or cyclic graph.

1. Single-Level Directory: The simplest directory structure is the single-level directory. All files are contained in the same directory, which is easy to support and understand. A single-level directory has significant limitations, when the number of files increases or when the system has more than one user. Since all files are in the same directory, they must have unique names.

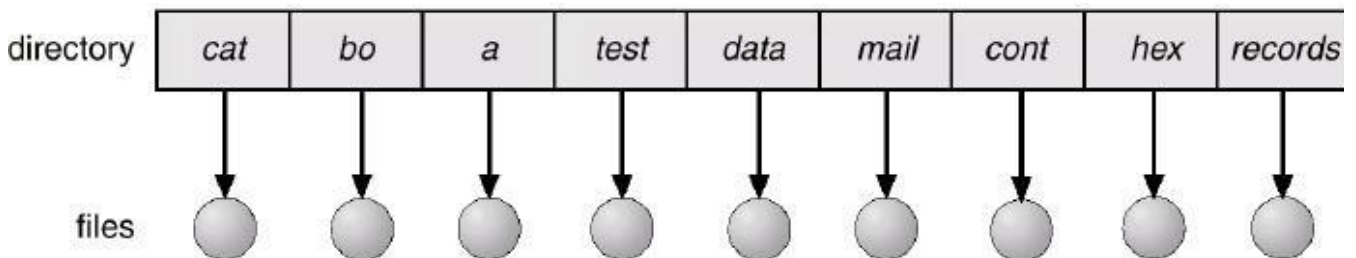

2. Two-Level Directory: In the two-level directory structure, each user has its own **user file directory (UFD)**. Each UFD has a similar structure, but lists only the files of a single user. When a user job starts or a user logs in, the system's **master file directory (MFD)** is searched. The MFD is indexed by user name or account number, and each entry points to the UFD for that user.

When a user refers to a particular file, only his own UFD is searched. Different users may have files with the same name, as long as all the file names within each UFD are unique.

To create a file for a user, the operating system searches only that user's UFD to ascertain whether another file of that name exists. To delete a file, the operating system confines its search to the local UFD; thus, it cannot accidentally delete another user's file that has the same name.

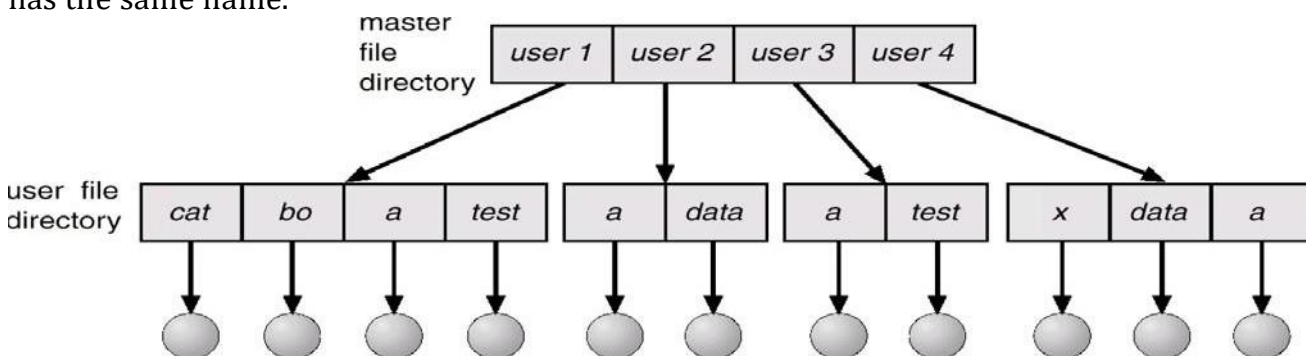

3. Tree-structured directories: A tree structure is a more powerful and flexible approach to organize files and directories in hierarchical. There is a master directory, which has under it a number of user directories. Each of these user directories may have sub-directories and files as entries. This is true at any level: That is, at any level, a directory may consist of entries for subdirectories and/or entries for files.

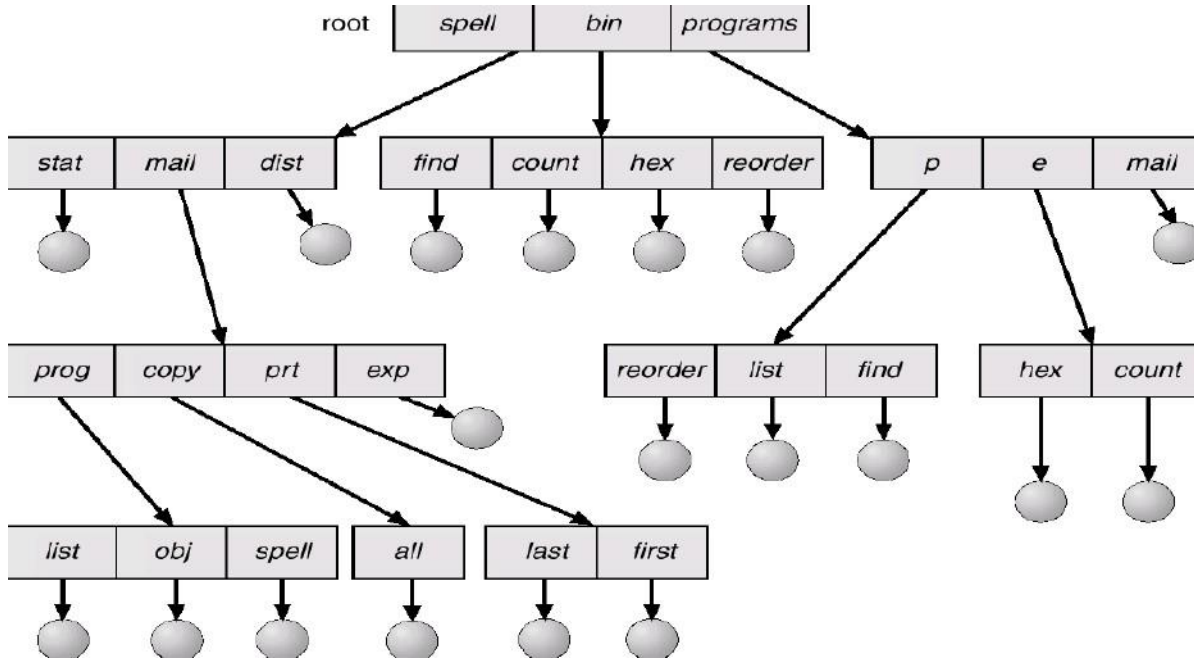

4. Acyclic-Graph Directories:

An **acyclic graph** allows directories to have shared subdirectories and files. The *same* file or subdirectory may be in two different directories. An acyclic graph is a natural generalization of the tree structured directory scheme.

A shared file (or directory) is not the same as two copies of the file. With two copies, each programmer can view the copy rather than the original, but if one programmer changes the file, the changes will not appear in the other's copy.

Shared files and subdirectories can be implemented in several ways. A common way is to create a new directory entry called a link. A **link** is a pointer to another file or subdirectory.

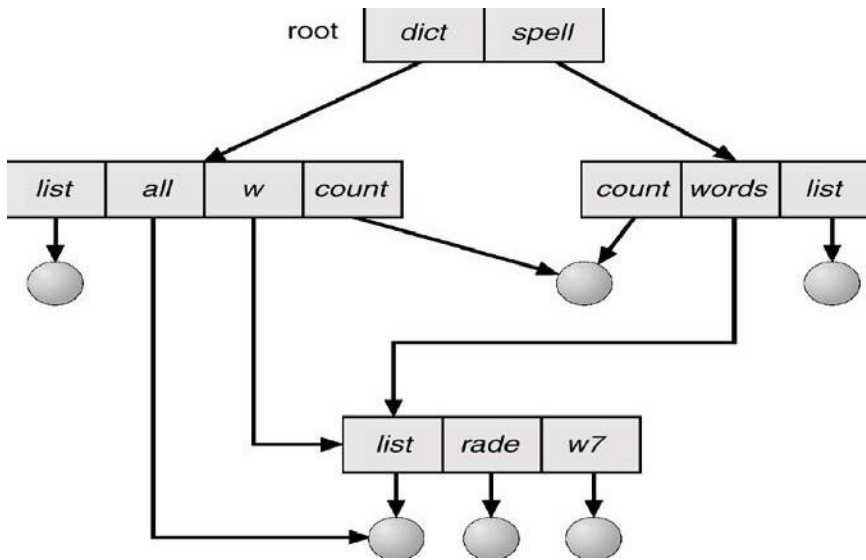

5. General Graph Directory:

When we add links to an existing tree-structured directory, the tree structure is destroyed, resulting in a simple graph structure.

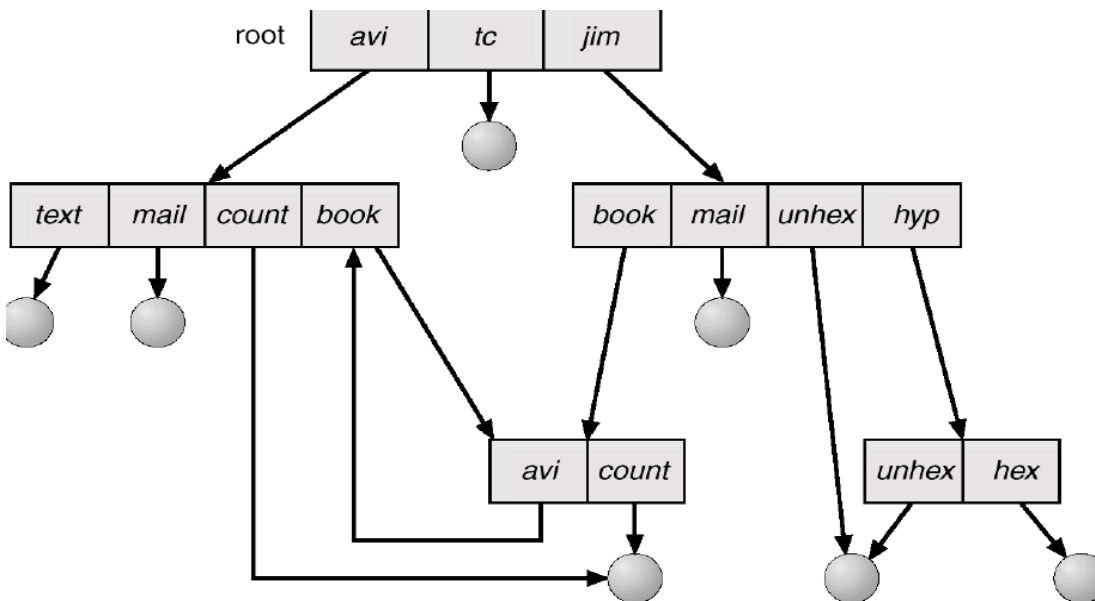

SECONDARY STORAGE STRUCTURE

DISKS STRUCTURE

Magnetic disks provide the bulk of secondary storage for modern computer systems. Each disk **platter** has a flat circular shape, like a CD. Common platter diameters range from 1.8 to 5.25 inches. The two surfaces of a platter are covered with a magnetic material. We store information by recording it magnetically on the platters.

A read-write head "flies" just above each surface of every platter. The heads are attached to a **disk arm**, which moves all the heads as a unit. The surface of a platter is logically divided into circular **tracks**, which are subdivided into **sectors**. The set of tracks that are at one arm position forms a **cylinder**. There may be thousands of concentric cylinders in a disk drive, and each track may contain hundreds of sectors. The storage capacity of common disk drives is measured in gigabytes.

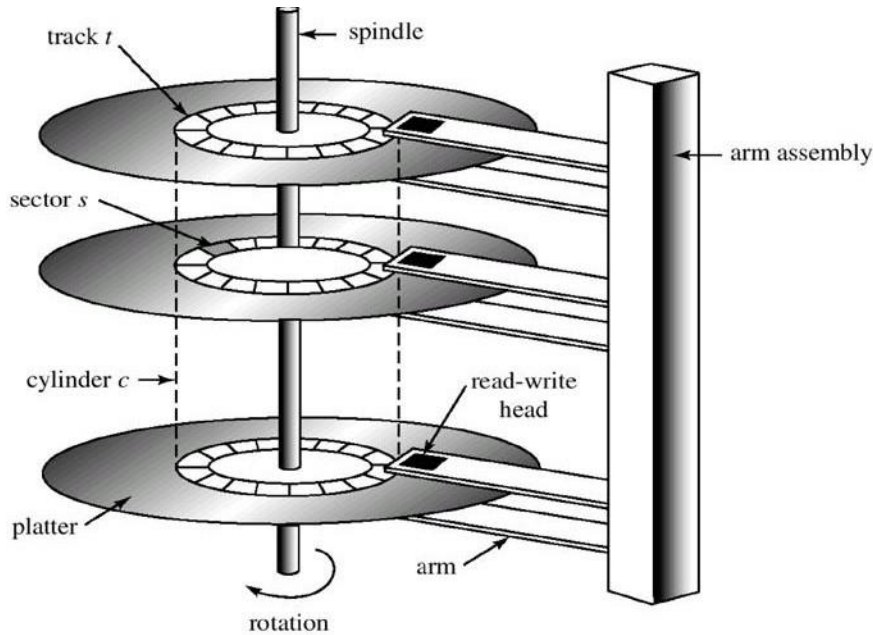

(Structure of Magnetic disks (Harddisk drive))

When the disk is in use, a drive motor spins it at high speed. Most drives rotate 60 to 200 times per second. Disk speed has two parts. The **transfer rate** is the rate at which data flow between the drive and the computer. The **positioning time (or random-access time)** consists of **seek time** and **rotational latency**. The **seek time** is the time to move the disk arm to the desired cylinder. And the **rotational latency** is the time for the desired sector to rotate to the disk head. Typical disks can transfer several megabytes of data per second and they have seek times and rotational latencies of several milliseconds.

Capacity of Magnetic disks(C) = S x T x P x N

Where S= no. of surfaces = 2 x no. of disks, T= no. of tracks in a surface,

P= no. of sectors per track, N= size of each sector

Transfer Time: The transfer time to or from the disk depends on the rotation speed of the disk in the following fashion:

$$T = b / (r \times N)$$

Where T= transfer time, b=number of bytes to be transferred, N= number of bytes on a track, r= rotation speed, in revolutions per second.

Modern disk drives are addressed as large one-dimensional arrays of **logical blocks**, where the logical block is the smallest unit of transfer. The one-dimensional array of logical blocks is mapped onto the sectors of the disk sequentially. Sector 0 is the first sector of the first track on the outermost cylinder. The mapping proceeds in order through that track, then through the rest of the tracks in that cylinder, and then through the rest of the cylinders from outermost to innermost.

By using this mapping, we can convert a logical block number into an old-style disk address that consists of a cylinder number, a track number within that cylinder, and a sector number within that track. In practical, it is difficult to perform this translation, for two reasons. First, most disks have some defective sectors, but the mapping hides this by substituting spare sectors from elsewhere on the disk. Second, the number of sectors per track is not a constant on some drives.

The density of bits per track is uniform. This is called **Constant linear velocity (CLV)**. The disk rotation speed can stay constant and the density of bits decreases from inner tracks to outer tracks to keep the data rate constant. This method is used in hard disks and is known as **constant angular velocity (CAV)**.

DISK SCHEDULING

The **seek time** is the time for the disk arm to move the heads to the cylinder containing the desired sector. The **rotational latency** is the time waiting for the disk to rotate the desired sector to the disk head. The disk **bandwidth** is the total number of bytes transferred divided by the total time between the first request for service and the completion of the last transfer.

We can improve both the access time and the bandwidth by scheduling the servicing of disk I/O requests in a good order. Several algorithms exist to schedule the servicing of disk I/O requests as follows:

1. FCFS Scheduling

The simplest form of scheduling is first-in-first-out (FIFO) scheduling, which processes items from the queue in sequential order. We illustrate this with a request queue (0-199):

98, 183, 37, 122, 14, 124, 65, 67

Consider now the Head pointer is in cylinder 53.

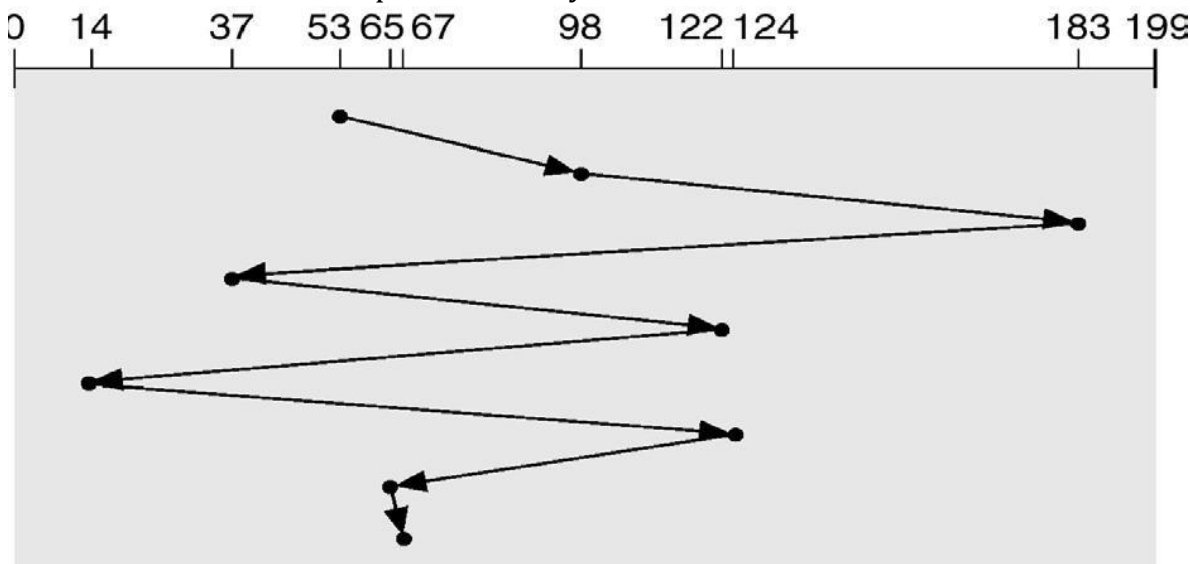

(FCFS disk scheduling)

2. SSTF Scheduling

It stands for shortest-seek-time-first (SSTF) algorithm. The SSTF algorithm selects the request with the minimum seek time from the current head position. Since seek time increases with the number of cylinders traversed by the head, SSTF chooses the pending request closest to the current head position. We illustrate this with a request queue (0-199):

98, 183, 37, 122, 14, 124, 65, 67

Consider now the Head pointer is in cylinder 53.

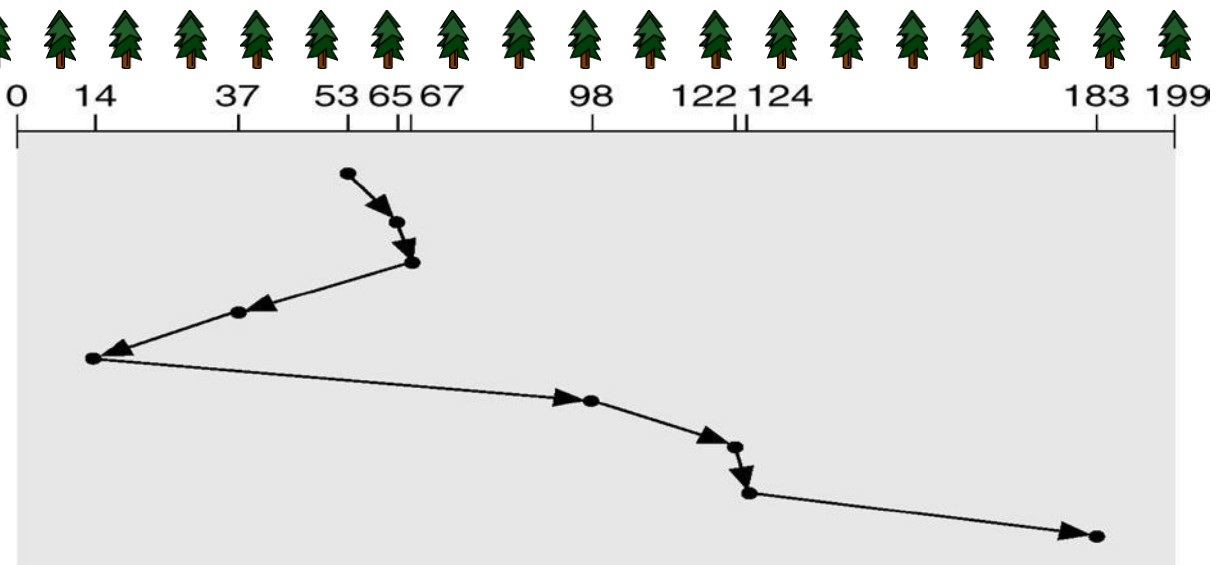

(SSTF disk scheduling)

3. SCAN Scheduling

In the SCAN algorithm, the disk arm starts at one end of the disk, and moves toward the other end, servicing requests as it reaches each cylinder, until it gets to the other end of the disk. At the other end, the direction of head movement is reversed, and servicing continues. The head continuously scans back and forth across the disk. We illustrate this with a request queue (0-199): 98, 183, 37, 122, 14, 124, 65, 67

Consider now the Head pointer is in cylinder 53.

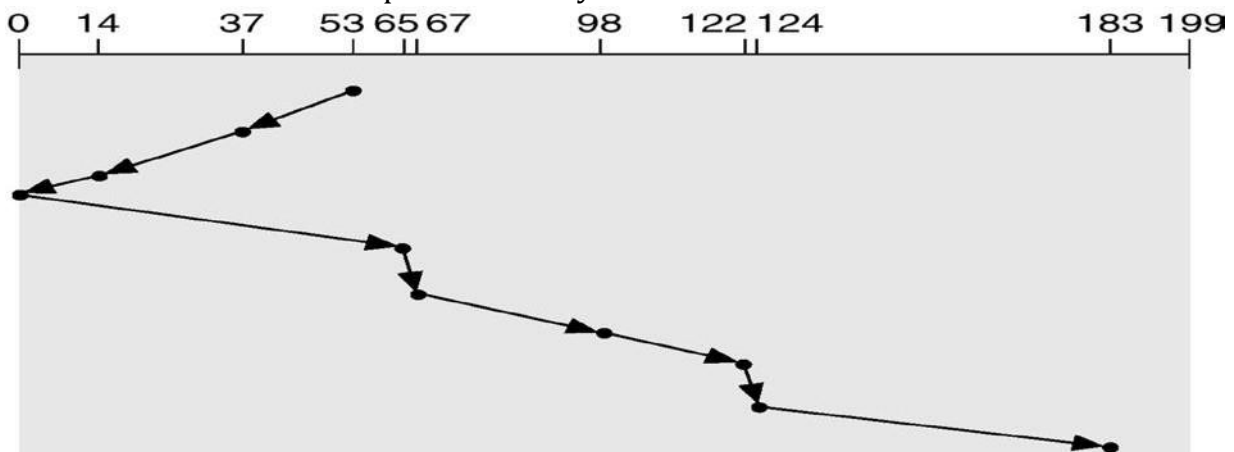

(SCAN disk scheduling)

4. C-SCAN Scheduling

Circular **SCAN (C-SCAN)** scheduling is a variant of SCAN designed to provide a more uniform wait time. Like SCAN, C-SCAN moves the head from one end of the disk to the other, servicing requests along the way. When the head reaches the other end, it immediately returns to the beginning of the disk, without servicing any requests on the return trip. The C-SCAN scheduling algorithm essentially treats the cylinders as a circular list that wraps around from the final cylinder to the first one. We illustrate this with a request queue (0-199): 98, 183, 37, 122, 14, 124, 65, 67. Consider now the Head pointer is in cylinder 53.

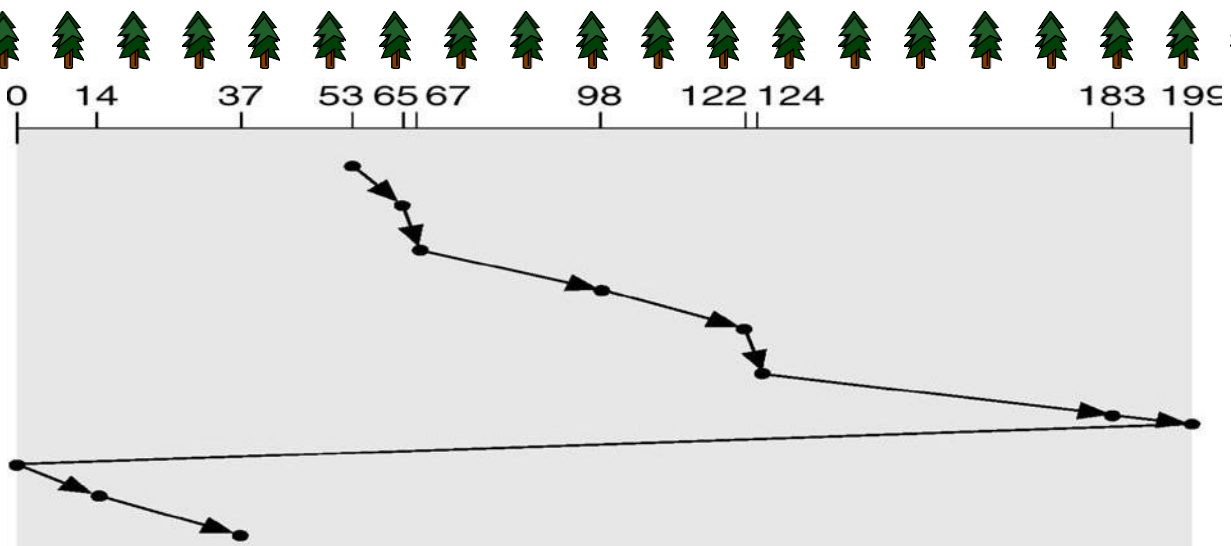

(C-SCAN disk scheduling)

5. LOOK Scheduling

Practically, both SCAN and C-SCAN algorithm is not implemented this way. More commonly, the arm goes only as far as the final request in each direction. Then, it reverses direction immediately, without going all the way to the end of the disk. These versions of SCAN and C-SCAN are called **LOOK** and **C-LOOK** scheduling, because they look for a request before continuing to move in a given direction. We illustrate this with a request queue (0-199): 98, 183, 37, 122, 14, 124, 65, 67

Consider now the Head pointer is in cylinder 53.

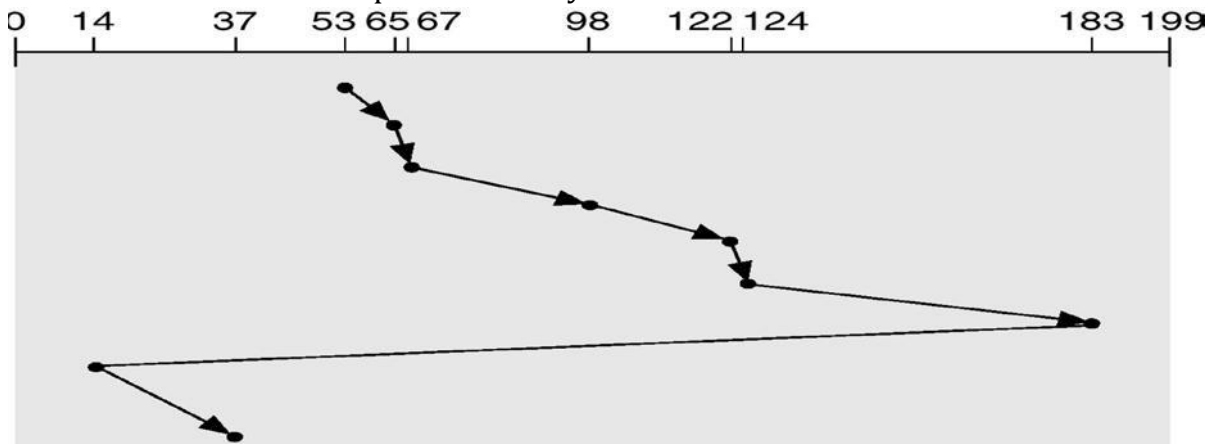

(C-LOOK disk scheduling)

Selection of a Disk-Scheduling Algorithm

- SSTF is common and has a natural appeal.
- SCAN and C-SCAN perform better for systems that place a heavy load on the disk.
- Performance depends on the number and types of requests.
- Requests for disk service can be influenced by the file allocation method.
- The disk-scheduling algorithm should be written as a separate module of the operating system, allowing it to be replaced with a different algorithm if necessary.
- Either SSTF or LOOK is a reasonable choice for the default algorithm.

DISK MANAGEMENT

The operating system is responsible for several aspects of disk management.

Disk Formatting



A new magnetic disk is a blank slate. It is just platters of a magnetic recording material. Before a disk can store data, it must be divided into sectors that the disk controller can read and write. This process is called low-level formatting (or **physical formatting**).

Low-level formatting fills the disk with a special data structure for each sector. The data structure for a sector consists of a header, a data area, and a trailer. The header and trailer contain information used by the disk controller, such as a sector number and an **error-correcting code (ECC)**.

To use a disk to hold files, the operating system still needs to record its own data structures on the disk. It does so in two steps. The first step is to **partition** the disk into one or more groups of cylinders. The operating system can treat each partition as though it were a separate disk. For instance, one partition can hold a copy of the operating system's executable code, while another holds user files. After partitioning, the second step is **logical formatting** (or creation of a file system). In this step, the operating system stores the initial file-system data structures onto the disk.

Boot Block

When a computer is powered up or rebooted, it needs to have an initial program to run. This initial program is called bootstrap program. It initializes all aspects of the system (i.e. from CPU registers to device controllers and the contents of main memory) and then starts the operating system.

To do its job, the bootstrap program finds the operating system kernel on disk, loads that kernel into memory, and jumps to an initial address to begin the operating-system execution.

For most computers, the bootstrap is stored in read-only memory (**ROM**). This location is convenient, because ROM needs no initialization and is at a fixed location that the processor can start executing when powered up or reset. And since ROM is read only, it cannot be infected by a computer virus. The problem is that changing this bootstrap code requires changing the ROM hardware chips.

For this reason, most systems store a tiny bootstrap loader program in the boot ROM, whose only job is to bring in a full bootstrap program from disk. The full bootstrap program can be changed easily: A new version is simply written onto the disk. The full bootstrap program is stored in a partition (at a fixed location on the disk) is called **the boot blocks**. A disk that has a boot partition is called a **boot disk or system disk**.

Bad Blocks

Since disks have moving parts and small tolerances, they are prone to failure. Sometimes the failure is complete, and the disk needs to be replaced, and its contents restored from backup media to the new disk.

More frequently, one or more sectors become defective. Most disks even come from the factory with bad blocks. Depending on the disk and controller in use, these blocks are handled in a variety of ways.

The controller maintains a list of bad blocks on the disk. The list is initialized during the low-level format at the factory, and is updated over the life of the disk. The controller can be told to replace each bad sector logically with one of the spare sectors. This scheme is known as sector sparing or forwarding.

SWAP-SPACE MANAGEMENT

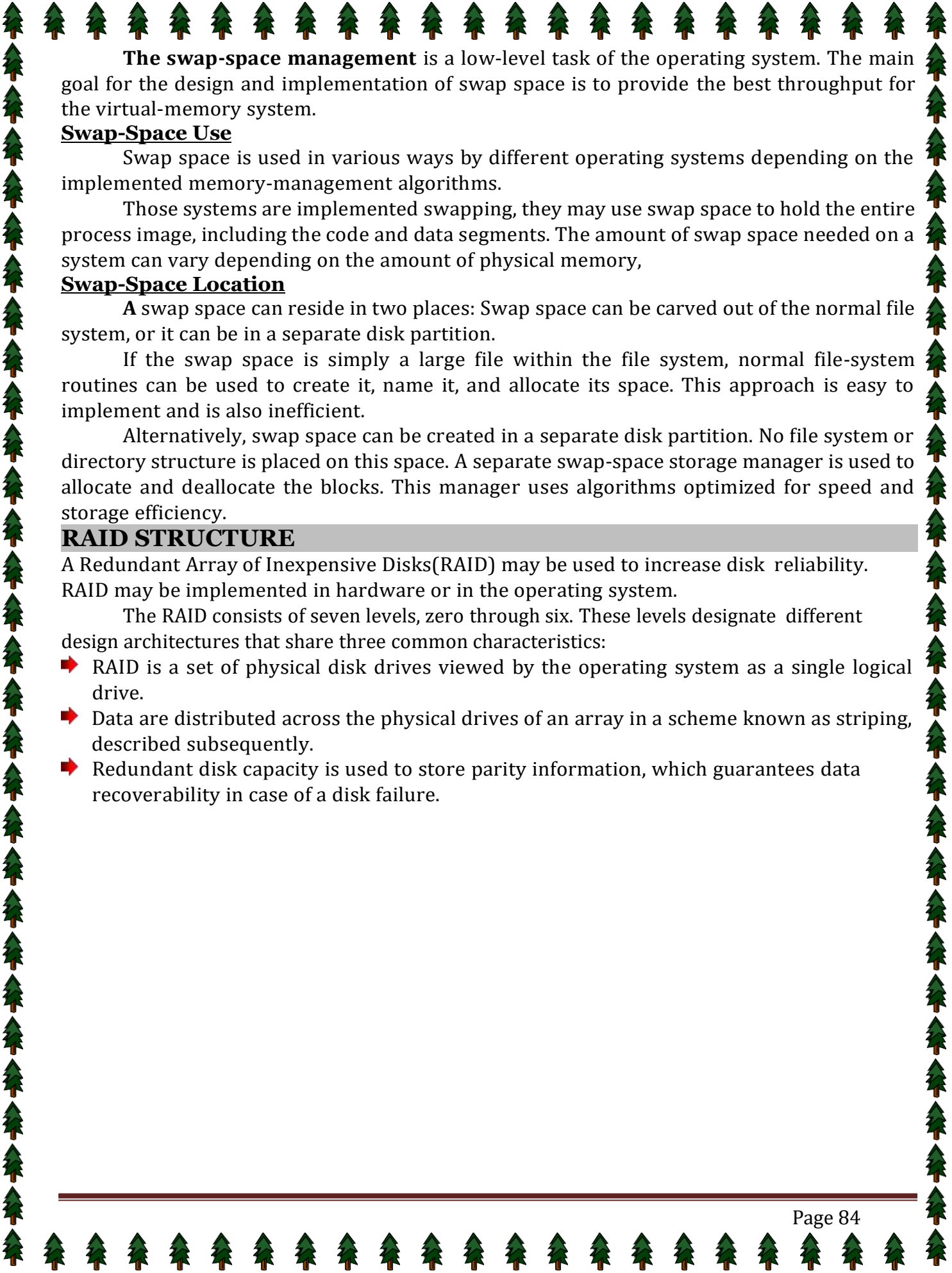

The swap-space management is a low-level task of the operating system. The main goal for the design and implementation of swap space is to provide the best throughput for the virtual-memory system.

Swap-Space Use

Swap space is used in various ways by different operating systems depending on the implemented memory-management algorithms.

Those systems are implemented swapping, they may use swap space to hold the entire process image, including the code and data segments. The amount of swap space needed on a system can vary depending on the amount of physical memory,

Swap-Space Location

A swap space can reside in two places: Swap space can be carved out of the normal file system, or it can be in a separate disk partition.

If the swap space is simply a large file within the file system, normal file-system routines can be used to create it, name it, and allocate its space. This approach is easy to implement and is also inefficient.

Alternatively, swap space can be created in a separate disk partition. No file system or directory structure is placed on this space. A separate swap-space storage manager is used to allocate and deallocate the blocks. This manager uses algorithms optimized for speed and storage efficiency.

RAID STRUCTURE

A Redundant Array of Inexpensive Disks(RAID) may be used to increase disk reliability. RAID may be implemented in hardware or in the operating system.

The RAID consists of seven levels, zero through six. These levels designate different design architectures that share three common characteristics:

- RAID is a set of physical disk drives viewed by the operating system as a single logical drive.
- Data are distributed across the physical drives of an array in a scheme known as striping, described subsequently.
- Redundant disk capacity is used to store parity information, which guarantees data recoverability in case of a disk failure.

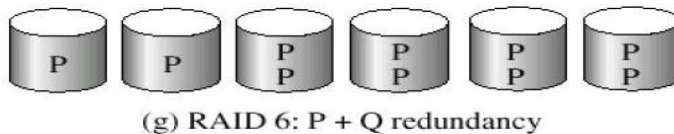
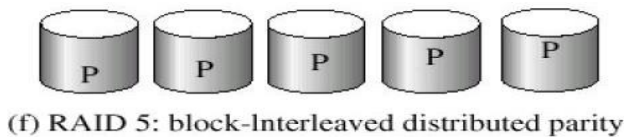
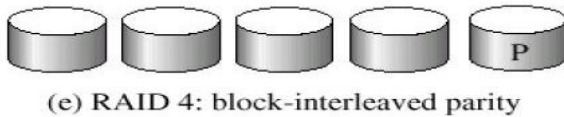
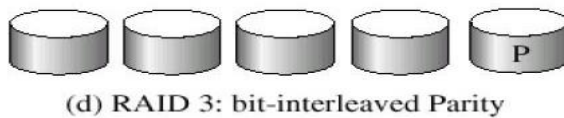
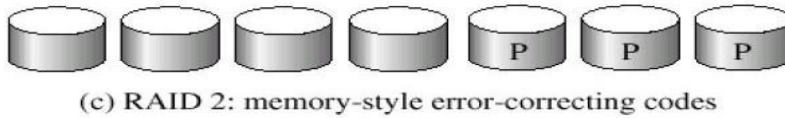
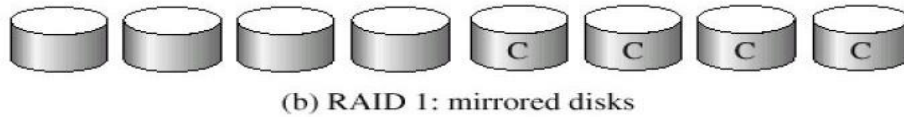
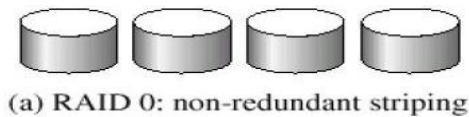

(RAID levels)

(Here *P* indicates error-correcting bits and *C* indicates a second copy of the data)

The RAID levels are described as follows:

- **RAID Level 0:** RAID level 0 refers to disk arrays with striping at the level of blocks, but without any redundancy (such as parity bits). Figure(a) shows an array of size 4.
- **RAID Level 1:** RAID level 1 refers to disk mirroring. Figure (b) shows a mirrored organization that holds four disks' worth of data.
- **RAID Level 2:** RAID level 2 is also known as **memory-style error-correcting code (ECC) organization**. Each byte in a memory system may have a parity bit associated with it that records whether the numbers of bits in the byte set to 1 is even (parity=0) or odd (parity=1). The idea of ECC can be used directly in disk arrays via striping of bytes across disks.
- **RAID level 3:** RAID level 3, or **bit-interleaved parity organization**, improves on level 2 by noting that, disk controllers can detect whether a sector has been read correctly, so a single parity bit can be used for error correction, as well as for detection. The idea is as follows. If one of the sectors gets damaged, we know exactly which sector it is, and, for each bit in the

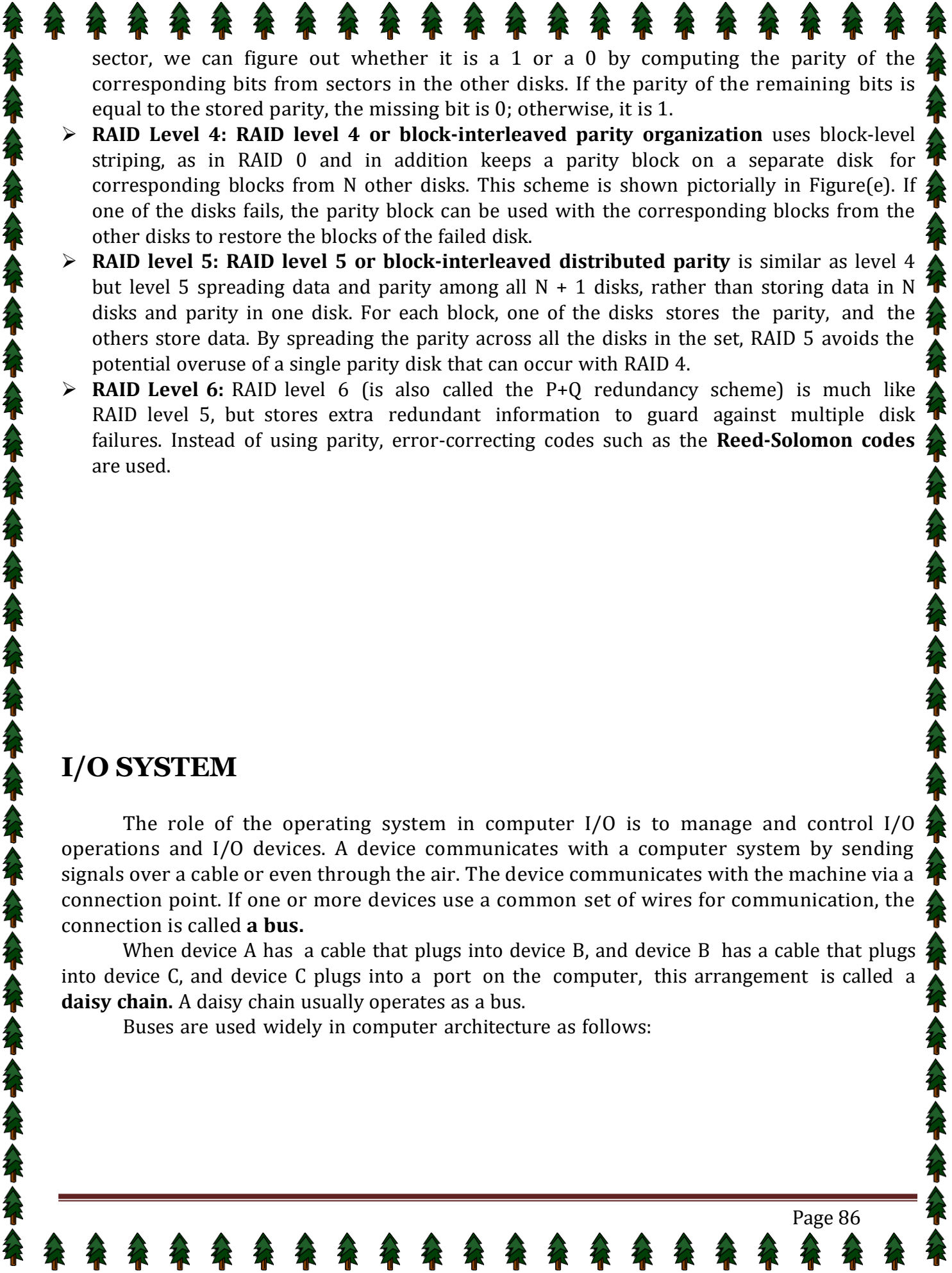

sector, we can figure out whether it is a 1 or a 0 by computing the parity of the corresponding bits from sectors in the other disks. If the parity of the remaining bits is equal to the stored parity, the missing bit is 0; otherwise, it is 1.

- **RAID Level 4: RAID level 4 or block-interleaved parity organization** uses block-level striping, as in RAID 0 and in addition keeps a parity block on a separate disk for corresponding blocks from N other disks. This scheme is shown pictorially in Figure(e). If one of the disks fails, the parity block can be used with the corresponding blocks from the other disks to restore the blocks of the failed disk.
- **RAID level 5: RAID level 5 or block-interleaved distributed parity** is similar as level 4 but level 5 spreading data and parity among all N + 1 disks, rather than storing data in N disks and parity in one disk. For each block, one of the disks stores the parity, and the others store data. By spreading the parity across all the disks in the set, RAID 5 avoids the potential overuse of a single parity disk that can occur with RAID 4.
- **RAID Level 6:** RAID level 6 (is also called the P+Q redundancy scheme) is much like RAID level 5, but stores extra redundant information to guard against multiple disk failures. Instead of using parity, error-correcting codes such as the **Reed-Solomon codes** are used.

I/O SYSTEM

The role of the operating system in computer I/O is to manage and control I/O operations and I/O devices. A device communicates with a computer system by sending signals over a cable or even through the air. The device communicates with the machine via a connection point. If one or more devices use a common set of wires for communication, the connection is called a **bus**.

When device A has a cable that plugs into device B, and device B has a cable that plugs into device C, and device C plugs into a port on the computer, this arrangement is called a **daisy chain**. A daisy chain usually operates as a bus.

Buses are used widely in computer architecture as follows:

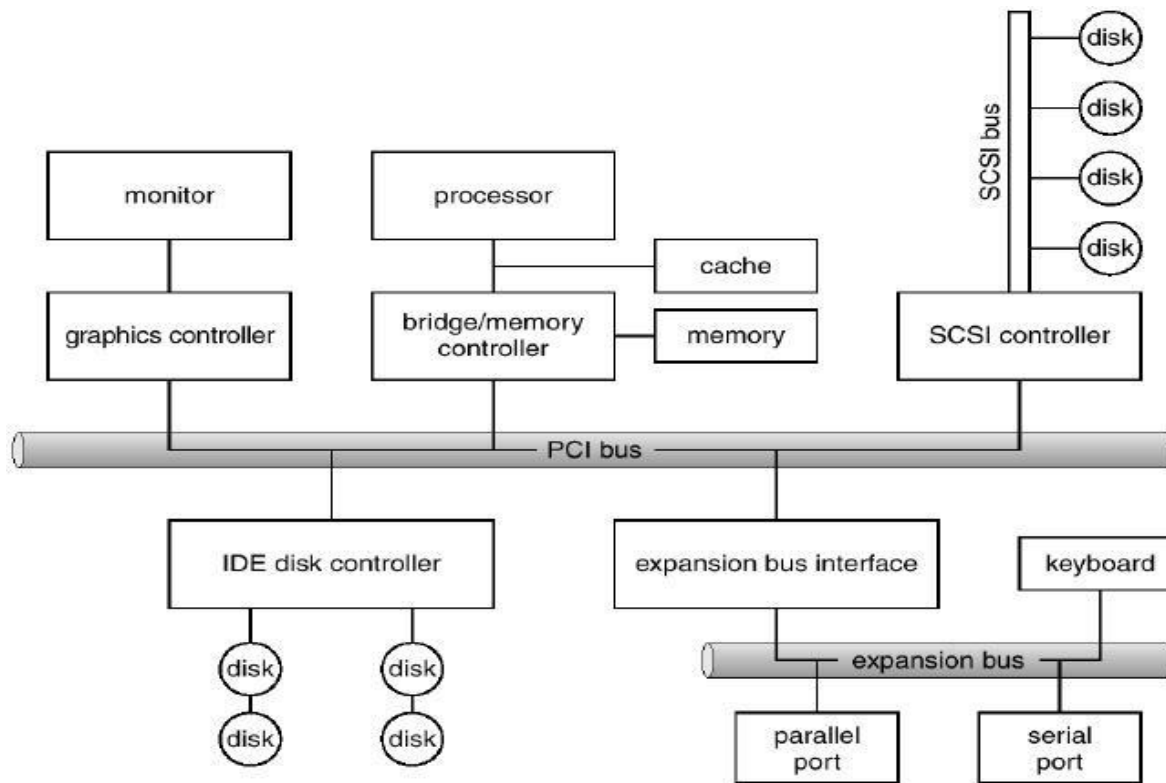

(A typical PC bus structure)

This figure shows a **PCI** bus (the common PC system bus) that connects the processor-memory subsystem to the fast devices, and an expansion bus that connects relatively slow devices such as the keyboard and serial and parallel ports. In the upper-right portion of the figure, four disks are connected together on a SCSI bus plugged into a SCSI controller.

A controller is a collection of electronics that can operate a port, a bus, or a device. A serial-port controller is a simple device controller. It is a single chip (or portion of a chip) in the computer that controls the signals on the wires of a serial port.

Since the SCSI protocol is complex, the SCSI bus controller is often implemented as a separate circuit board (or a host adapter) that plugs into the computer. It contains a processor, microcode, and some private memory to enable it to process the SCSI protocol messages.

Some devices have their own built-in controllers. This board is the disk controller. It has microcode and a processor to do many tasks, such as bad-sector mapping, prefetching, buffering, and caching.

An I/O port consists of four registers, called the status, control, data-in, and data-out registers.

- The status register contains bits that can be read by the host. These bits indicate states such as whether the current command has completed, whether a byte is available to be read from the data-in register, and whether there has been a device error.
- The control register can be written by the host to start a command or to change the mode of a device.
- The data-in register is read by the host to get input.
- The data-out register is written by the host to send output.

The external devices can be grouped into three categories:

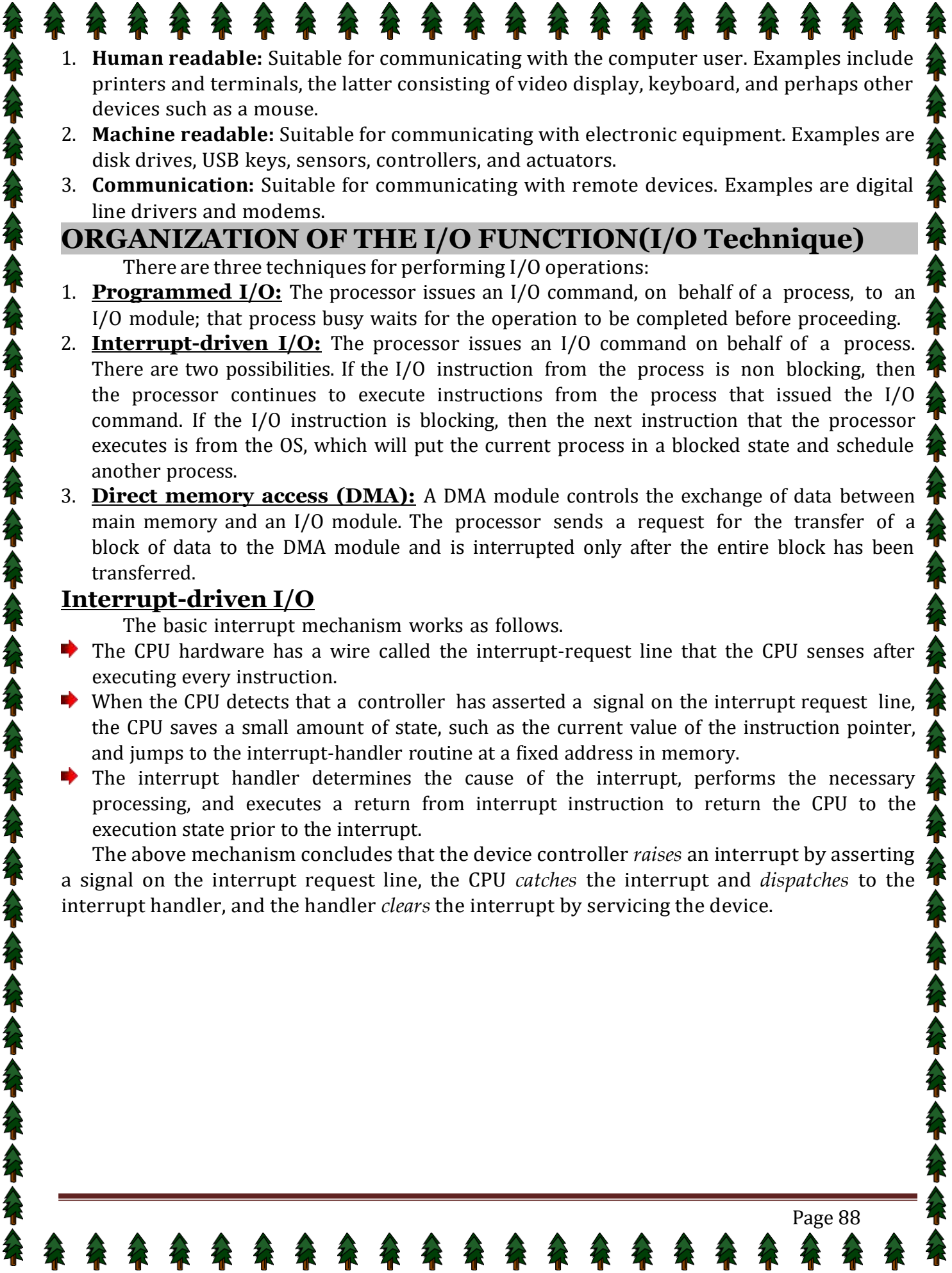
- 
1. **Human readable:** Suitable for communicating with the computer user. Examples include printers and terminals, the latter consisting of video display, keyboard, and perhaps other devices such as a mouse.
 2. **Machine readable:** Suitable for communicating with electronic equipment. Examples are disk drives, USB keys, sensors, controllers, and actuators.
 3. **Communication:** Suitable for communicating with remote devices. Examples are digital line drivers and modems.

ORGANIZATION OF THE I/O FUNCTION(I/O Technique)

There are three techniques for performing I/O operations:

1. **Programmed I/O:** The processor issues an I/O command, on behalf of a process, to an I/O module; that process busy waits for the operation to be completed before proceeding.
2. **Interrupt-driven I/O:** The processor issues an I/O command on behalf of a process. There are two possibilities. If the I/O instruction from the process is non blocking, then the processor continues to execute instructions from the process that issued the I/O command. If the I/O instruction is blocking, then the next instruction that the processor executes is from the OS, which will put the current process in a blocked state and schedule another process.
3. **Direct memory access (DMA):** A DMA module controls the exchange of data between main memory and an I/O module. The processor sends a request for the transfer of a block of data to the DMA module and is interrupted only after the entire block has been transferred.

Interrupt-driven I/O

The basic interrupt mechanism works as follows.

- The CPU hardware has a wire called the interrupt-request line that the CPU senses after executing every instruction.
- When the CPU detects that a controller has asserted a signal on the interrupt request line, the CPU saves a small amount of state, such as the current value of the instruction pointer, and jumps to the interrupt-handler routine at a fixed address in memory.
- The interrupt handler determines the cause of the interrupt, performs the necessary processing, and executes a return from interrupt instruction to return the CPU to the execution state prior to the interrupt.

The above mechanism concludes that the device controller *raises* an interrupt by asserting a signal on the interrupt request line, the CPU *catches* the interrupt and *dispatches* to the interrupt handler, and the handler *clears* the interrupt by servicing the device.

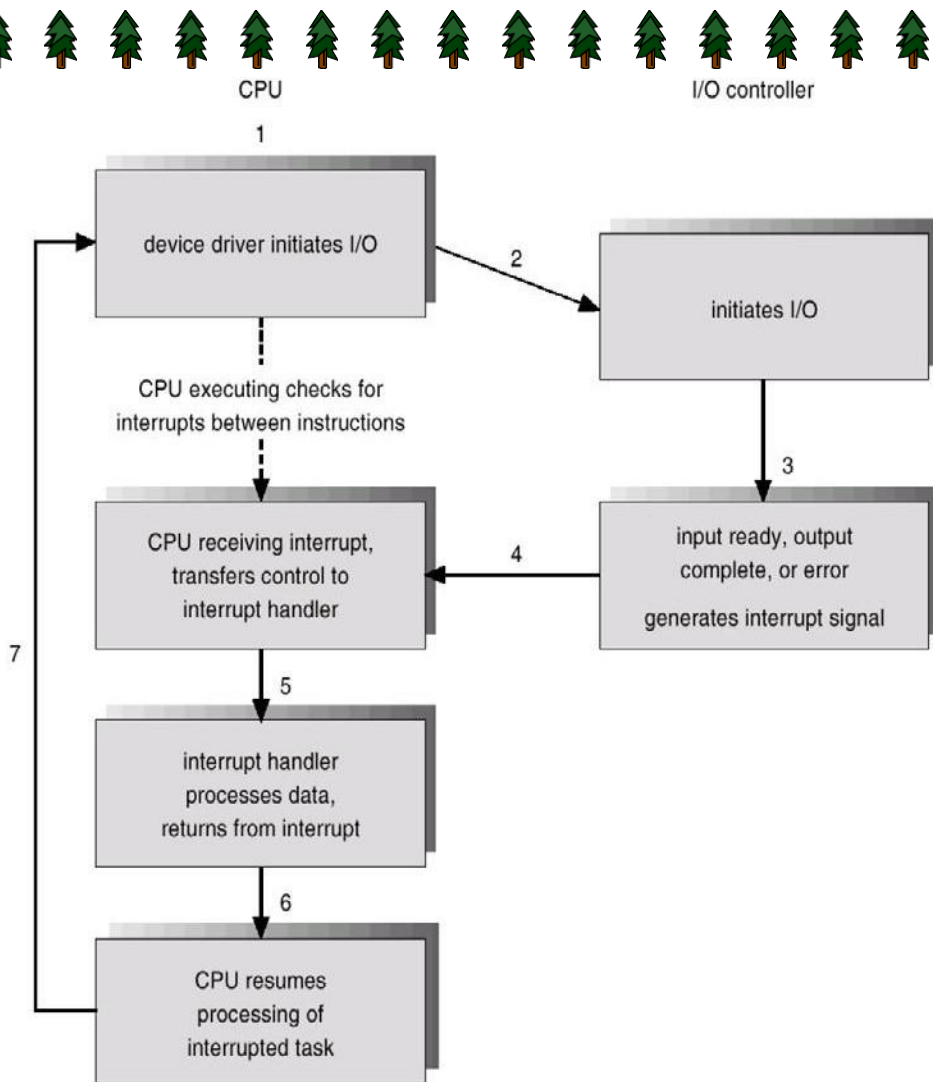

(Diagram of Interrupt-driven I/O cycle)

In a modern operating system, we need more sophisticated interrupt-handling features as follows:

- First, we need the ability to defer interrupt handling during critical processing.
- Second, we need an efficient way to dispatch to the proper interrupt handler for a device.
- Third, we need multilevel interrupts, so that the operating system can distinguish between high- and low-priority interrupts, and can respond with the appropriate degree of urgency.

In modern computer hardware, these three features are provided by the CPU and by the interrupt-controller hardware.

Direct Memory Access

The DMA unit is capable of mimicking the processor and of taking over control of the system bus just like a processor. It needs to do this to transfer data to and from memory over the system bus. The DMA technique works as follows:

⇒ When the processor wishes to read or write a block of data, it issues a command to the DMA module by sending to the DMA module the following information:

- Whether a read or write is requested, using the read or write control line between the processor and the DMA module.

- The address of the I/O device involved, communicated on the data lines.
- The starting location in memory to read from or write to, communicated on the data lines and stored by the DMA module in its address register.
- The number of words to be read or written, again communicated via the data lines and stored in the data count register.

- ⇒ Then the processor continues with other work. It has delegated this I/O operation to the DMA module.
- ⇒ The DMA module transfers the entire block of data, one word at a time, directly to or from memory, without going through the processor.
- ⇒ When the transfer is complete, the DMA module sends an interrupt signal to the processor. Thus, the processor is involved only at the beginning and end of the transfer.

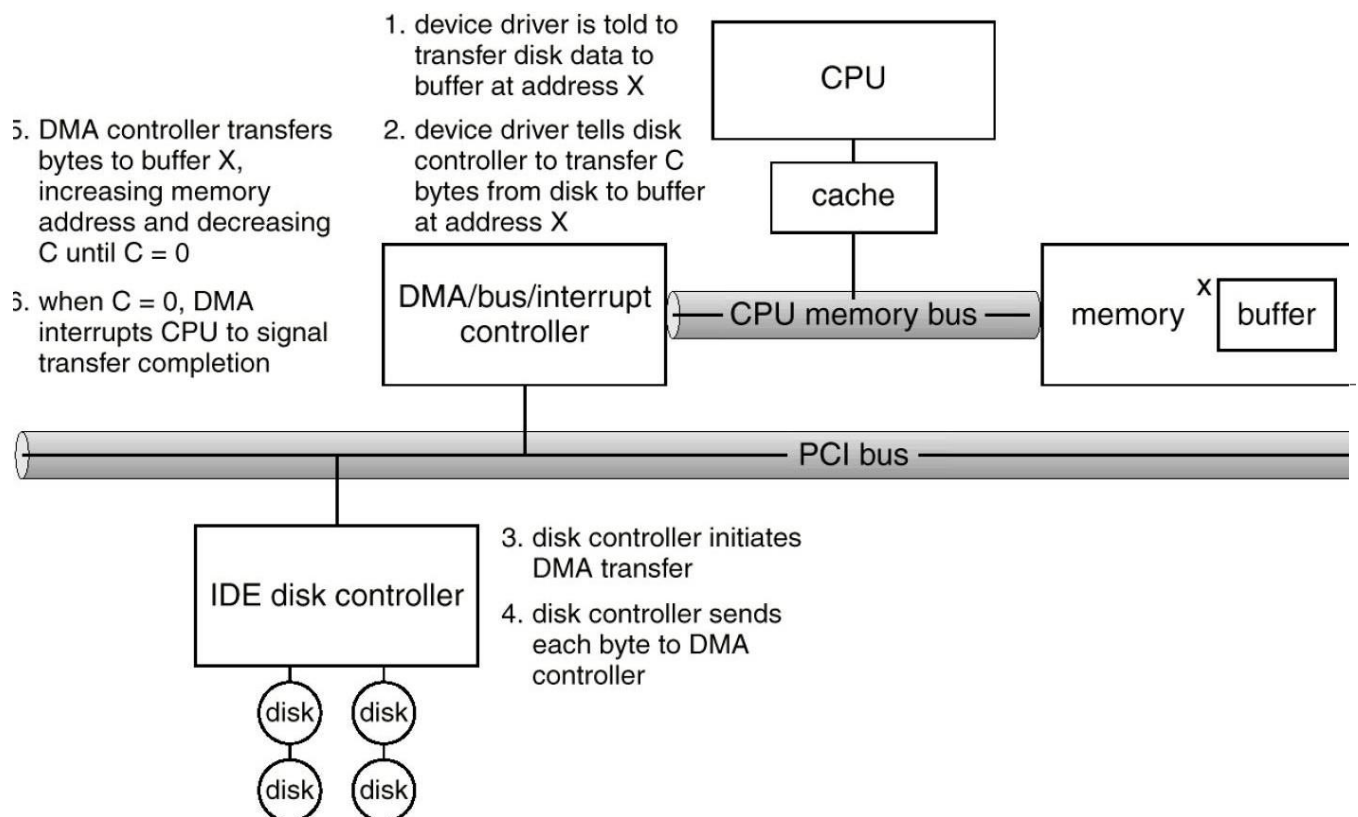

(Steps in a DMA transfer)

APPLICATION I/O INTERFACE

I/O system calls encapsulate device behaviors in generic classes. Each general kind is accessed through a standardized set of functions, called an interface. The differences are encapsulated in kernel modules called device drivers that internally are custom tailored to each device, but that export one of the standard interfaces.

Devices vary in many dimensions:

- Character-stream or block
- Sequential or random-access
- Sharable or dedicated
- Speed of operation
- read-write, read only, or write only

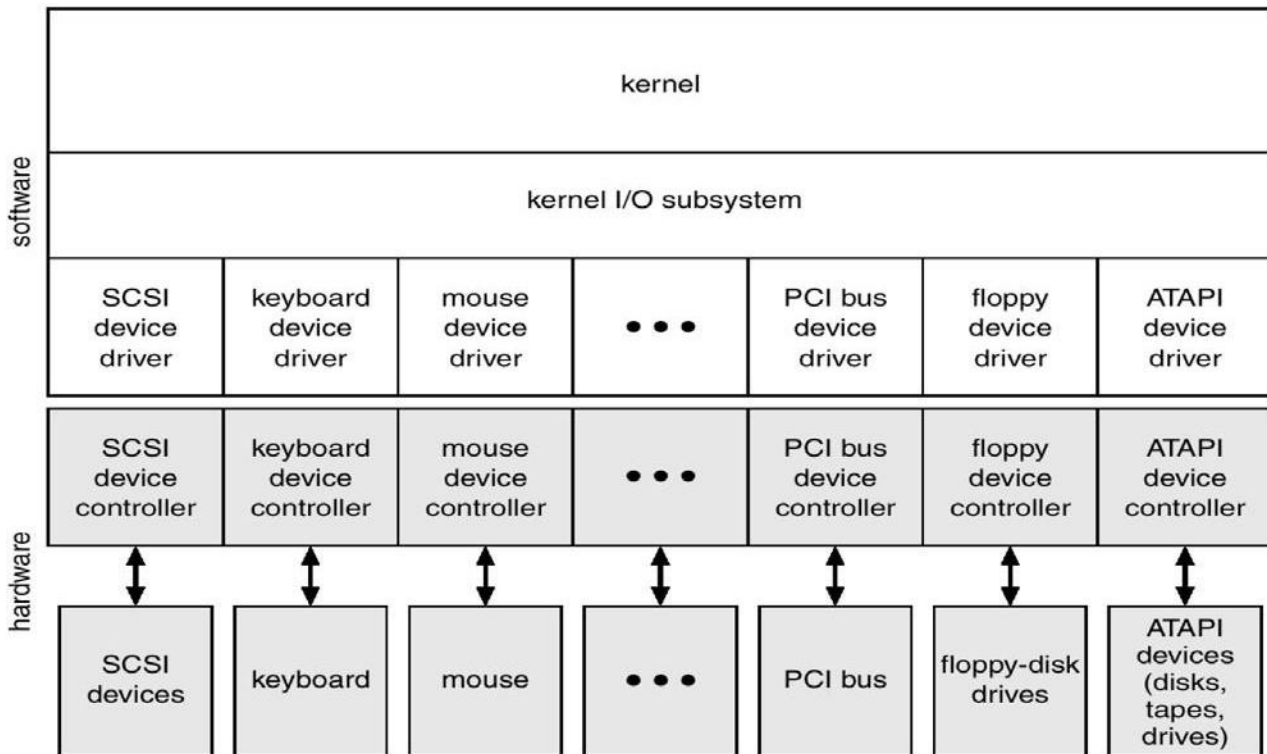

(Diagram of a kernel I/O structure)

The purpose of the device-driver layer is to hide the differences among device controllers from the I/O subsystem of the kernel, much as the I/O system calls encapsulate the behavior of devices in a few generic classes that hide hardware differences from applications. Making the I/O subsystem independent of the hardware simplifies the job of the operating-system developer. It also benefits the hardware manufacturers. They either design new devices to be compatible with an existing host controller interface (such as SCSI-2), or they write device drivers to interface the new hardware to popular operating systems. Thus, new peripherals can be attached to a computer without waiting for the operating-system vendor to develop support code.

KERNEL I/O SUBSYSTEM

Kernels provide many services related to I/O. Several services (i.e. scheduling, buffering, caching, spooling, device reservation and error handling) are provided by the kernel's I/O subsystem and build on the hardware and device driver infrastructure.

1. I/O Scheduling: It is used to schedule a set of I/O requests that means to determine a good order in which to execute them. Scheduling can improve overall system performance and can reduce the average waiting time for I/O to complete.

2. Buffering: A **buffer** is a memory area that stores data while they are transferred between two devices or between a device and an application. Buffering is done for three reasons.

- One reason is to cope with a speed mismatch between the producer and consumer of a data stream.

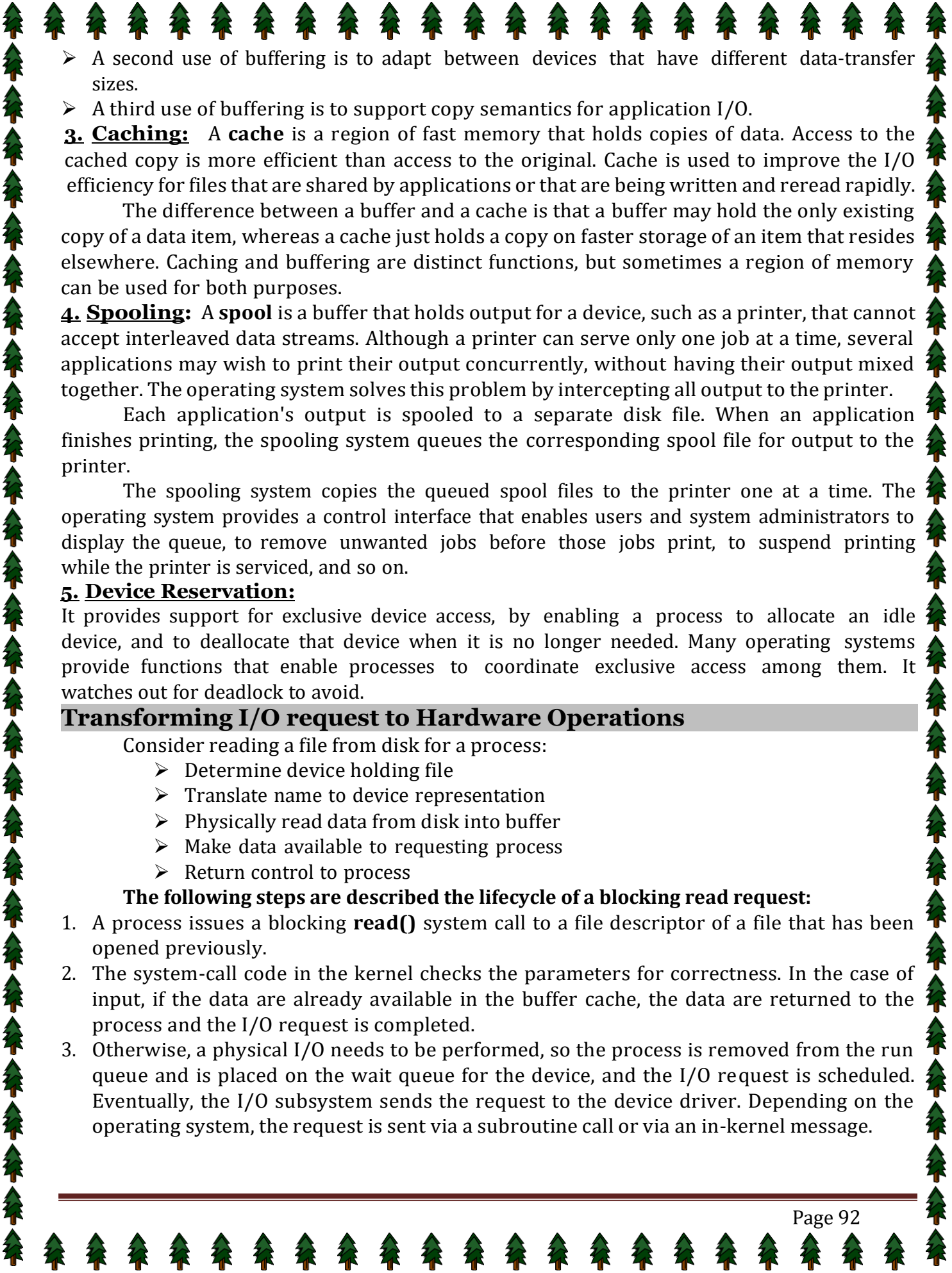
- 
- A second use of buffering is to adapt between devices that have different data-transfer sizes.
 - A third use of buffering is to support copy semantics for application I/O.

3. Caching: A **cache** is a region of fast memory that holds copies of data. Access to the cached copy is more efficient than access to the original. Cache is used to improve the I/O efficiency for files that are shared by applications or that are being written and reread rapidly.

The difference between a buffer and a cache is that a buffer may hold the only existing copy of a data item, whereas a cache just holds a copy on faster storage of an item that resides elsewhere. Caching and buffering are distinct functions, but sometimes a region of memory can be used for both purposes.

4. Spooling: A **spool** is a buffer that holds output for a device, such as a printer, that cannot accept interleaved data streams. Although a printer can serve only one job at a time, several applications may wish to print their output concurrently, without having their output mixed together. The operating system solves this problem by intercepting all output to the printer.

Each application's output is spooled to a separate disk file. When an application finishes printing, the spooling system queues the corresponding spool file for output to the printer.

The spooling system copies the queued spool files to the printer one at a time. The operating system provides a control interface that enables users and system administrators to display the queue, to remove unwanted jobs before those jobs print, to suspend printing while the printer is serviced, and so on.

5. Device Reservation:

It provides support for exclusive device access, by enabling a process to allocate an idle device, and to deallocate that device when it is no longer needed. Many operating systems provide functions that enable processes to coordinate exclusive access among them. It watches out for deadlock to avoid.

Transforming I/O request to Hardware Operations

Consider reading a file from disk for a process:

- Determine device holding file
- Translate name to device representation
- Physically read data from disk into buffer
- Make data available to requesting process
- Return control to process

The following steps are described the lifecycle of a blocking read request:

1. A process issues a blocking **read()** system call to a file descriptor of a file that has been opened previously.
2. The system-call code in the kernel checks the parameters for correctness. In the case of input, if the data are already available in the buffer cache, the data are returned to the process and the I/O request is completed.
3. Otherwise, a physical I/O needs to be performed, so the process is removed from the run queue and is placed on the wait queue for the device, and the I/O request is scheduled. Eventually, the I/O subsystem sends the request to the device driver. Depending on the operating system, the request is sent via a subroutine call or via an in-kernel message.

4. The device driver allocates kernel buffer space to receive the data, and schedules the I/O. Eventually, the driver sends commands to the device controller by writing into the device control registers.
5. The device controller operates the device hardware to perform the data transfer.
6. The driver may poll for status and data, or it may have set up a DMA transfer into kernel memory. We assume that the transfer is managed by a DMA controller, which generates an interrupt when the transfer completes.
7. The correct interrupt handler receives the interrupt via the interrupt-vector table, stores any necessary data, signals the device driver, and returns from the interrupt.
8. The device driver receives the signal, determines which I/O request completed, determines the request's status, and signals the kernel I/O subsystem that the request has been completed.
9. The kernel transfers data or returns codes to the address space of the requesting process, and moves the process from the wait queue back to the ready queue.
10. Moving the process to the ready queue unblocks the process. When the scheduler assigns the process to the CPU, the process resumes execution at the completion of the system call.

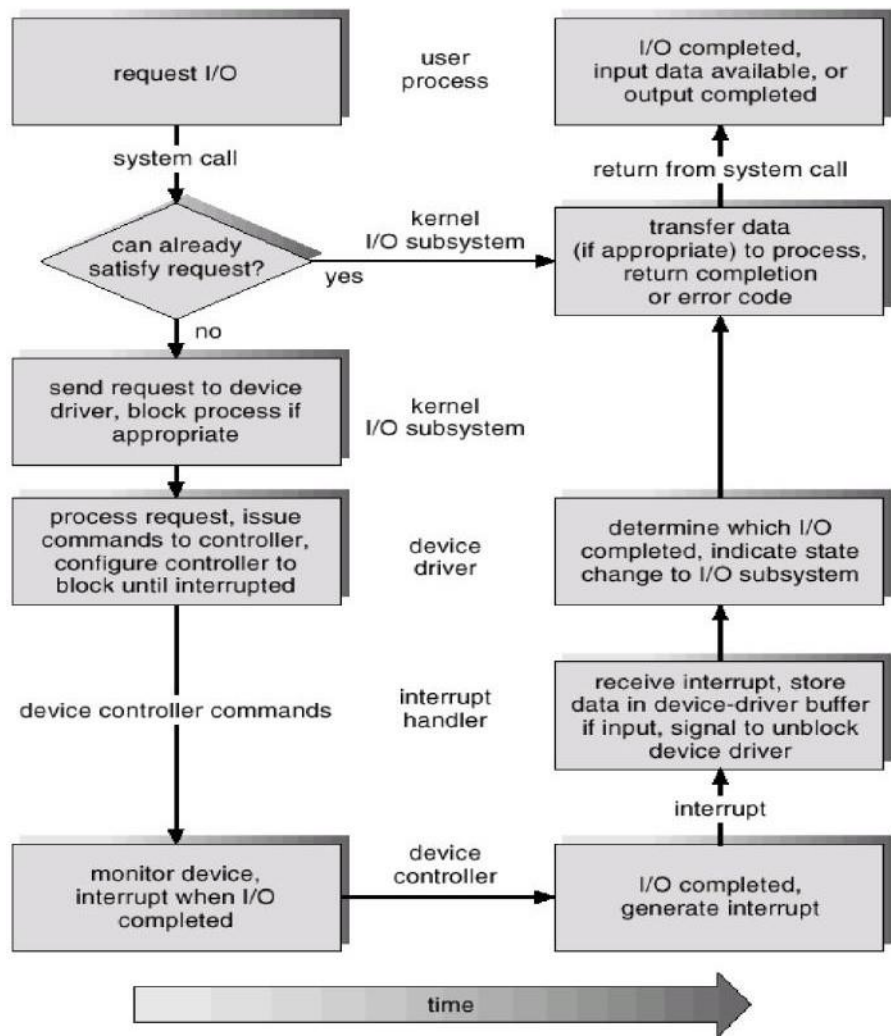

(The life cycle of an I/O request)